

U.I. Lapp GmbH	DATASHEET	
	SKINDICHT® SHV VITON®	54000015 14.11.2013

For high temperatures
Resistant to oils, solvents, acids and chemicals
Watertight
High strain relief
Robust



Optimum strain relief



Robust



Temperature-resistant



Application range

Watertight and high temperature-resistant cable gland with special conical VITON® sealing element.

Brickworks
Sewage treatment plants
Car wash sites

Design

1 fitting
2 washers
3 VITON® sealing cone
4 brass cones
5 compression screws

Note

Counter nut to be used: SKINDICHT® SM
SHV-VITON® 13,5/9/11

Remark

Viton® is a registered trademark of DuPont de Nemours
Photographs are not to scale and do not represent detailed images of the respective products.

Product Management	Document: SKINDICHT® SHV VITON®	1 / 3
--------------------	---------------------------------	-------

U.I. Lapp GmbH	DATASHEET	
	SKINDICHT® SHV VITON®	54000015 14.11.2013

Technical Data

Article designation / size:	SHV-V 9/9/6
Clamping range ØF (mm):	4,8 - 5,8
SW (mm):	17
Overall length, C (mm):	28,5
Thread length, D (mm):	6
Pieces / PU:	50
Caution:	The installation dimensions can be found in appendix T21
Material:	Body: nickel-plated brass Sealing cone: FKM O-ring: FKM
Protection rating:	IP 68 - 10 bar
Temperature range:	-15°C to +200°C

Product Management	Document: SKINDICHT® SHV VITON®	2 / 3
--------------------	---------------------------------	-------

U.I. Lapp GmbH	<h1>DATASHEET</h1>	 LAPP GROUP
	SKINDICHT® SHV VITON®	54000015 14.11.2013

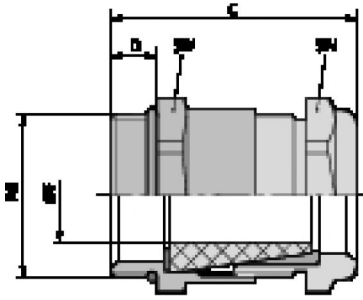

Product Management	Document: SKINDICHT® SHV VITON®	3 / 3
--------------------	---------------------------------	-------