

RoHS COMPLIANT

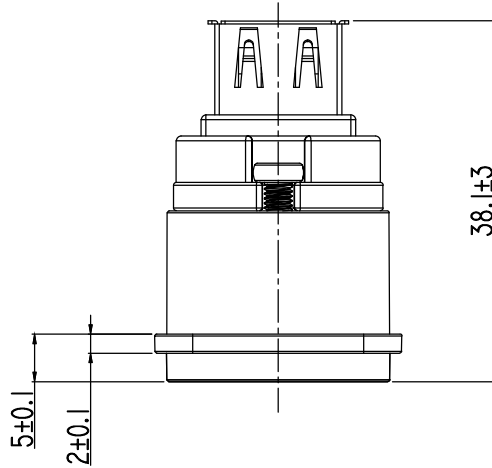

Panel cut out (Rear side)

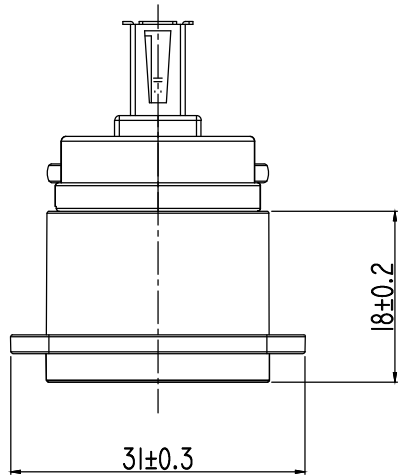
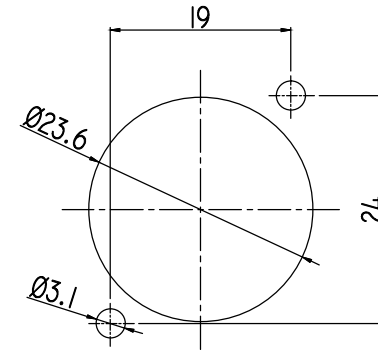

USB 2.0 Specification & Technical Data:

- Contact Resistance: 30 mΩ MAX
- Insulation Resistance: 1000 MΩ min
- Dielectric withstanding voltage: 500V AC one minut
- Rated Current 1.5 A
- Rated Voltage 5V
- Temperature Range 0°C-50°C
- (High-Speed): 25Mbps ~ 480Mbps (Max 480Mbps)
- (Full Speed): 500Kbps ~ 10Mbps (Max 12Mbps)
- (Low Speed): 10Kbps ~ 100Kbps (Max 1.5Mbps)

Material:

- Insulation : PBT
- Contact: Brass
- Shell: Brass
- Plating:
- Contact : Touch Area Golden Plating 1u"
- Soldering Area Tin Plating 40u" min
- Shell: Whole Area Nickel Plating 40u" min

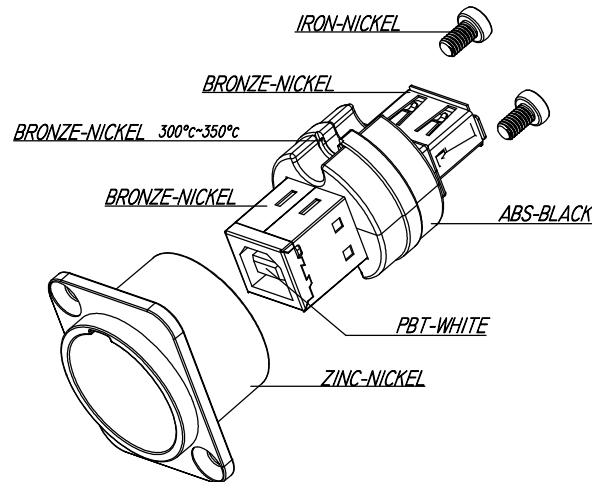
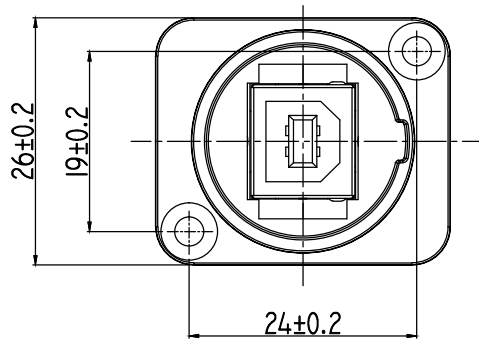
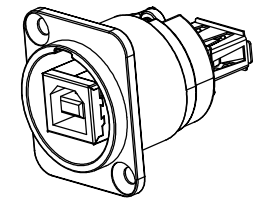

Contact	Standard A	Standard B
1	VBUS (4.75 - 5.25 V)	VBUS (4.4 - 5.25 V)
2	D-	D-
3	D+	D+
4	Earthing	Earthing

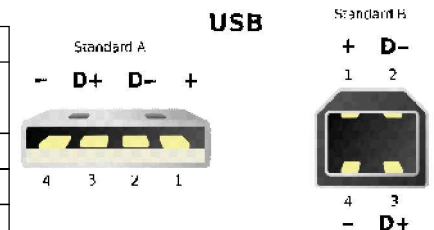

Cliff Electronic Components Ltd.

76 Holmethorpe Avenue, Holmethorpe Industrial Estate,
Redhill, Surrey, RH1 2PF, England, UK
Tel: 01737-771375 Fax: 01737-766012 Website: www.cliffuk.co.uk

PART No. CP30111

XLR

USB B FEMALE TO
USB A FEMALE