

Inbouwconnector voorwand - CA-06S1N8A6Y00 - 1619875

Please be informed that the data shown in this PDF Document is generated from our Online Catalog. Please find the complete data in the user's documentation. Our General Terms of Use for Downloads are valid (<http://download.phoenixcontact.com>)



Inbouwconnector voorwand, recht, afgeschermd: ja, SPEEDCON-vergrendeling, M23, aantal polen: 6, soort contact: bus, crimpaansluiting, afdichting axiaal, centrale bevestiging

Key commercial data

package_quantity	1
GTIN	4046356820912

classifications

eCl@ss

eCl@ss 4.0	272607xx
eCl@ss 4.1	27260701
eCl@ss 5.0	27143424
eCl@ss 5.1	27143424
eCl@ss 6.0	27143424
eCl@ss 7.0	27440209
eCl@ss 8.0	27440209

ETIM

ETIM 3.0	EC001121
ETIM 4.0	EC002635
ETIM 5.0	EC002635

UNSPSC

UNSPSC 6.01	43172015
UNSPSC 7.0901	43201404
UNSPSC 11	43172015
UNSPSC 12.01	43201404
UNSPSC 13.2	43201404

accessories

Beschermkappen

Inbouwconnector voorwand - CA-06S1N8A6Y00 - 1619875

accessories

SF-Z0019 - 1607449



RC-Z2059 - 1604225



RC-Z2469 - 1611797



Drawings

Inbouwconnector voorwand - CA-06S1N8A6Y00 - 1619875

Maatschets

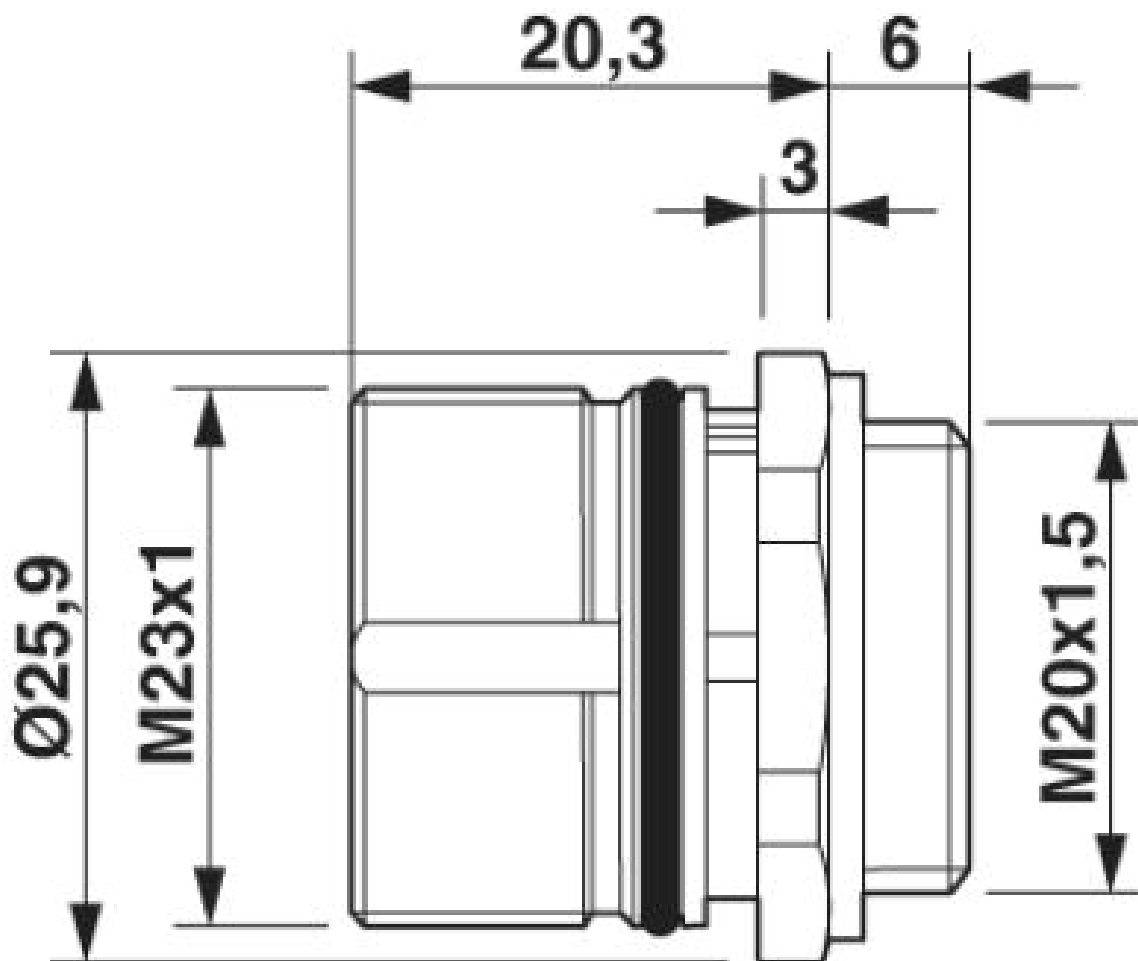

Inbouwconnector voorwand - CA-06S1N8A6Y00 - 1619875

Maatschets

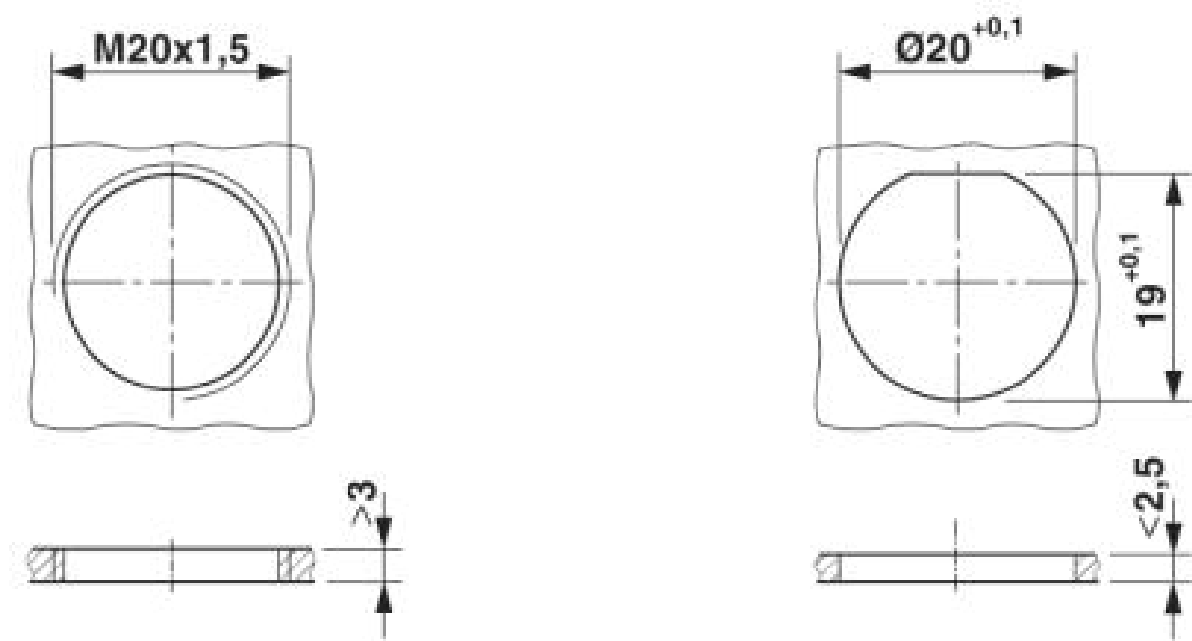

inbouwmaten:

Inbouwconnector voorwand - CA-06S1N8A6Y00 - 1619875

schematekening

