

**SEDECO MODEL NO. BD-0702 12V, 24V**  
**LED INDICATOR LIGHT**

Unit: mm

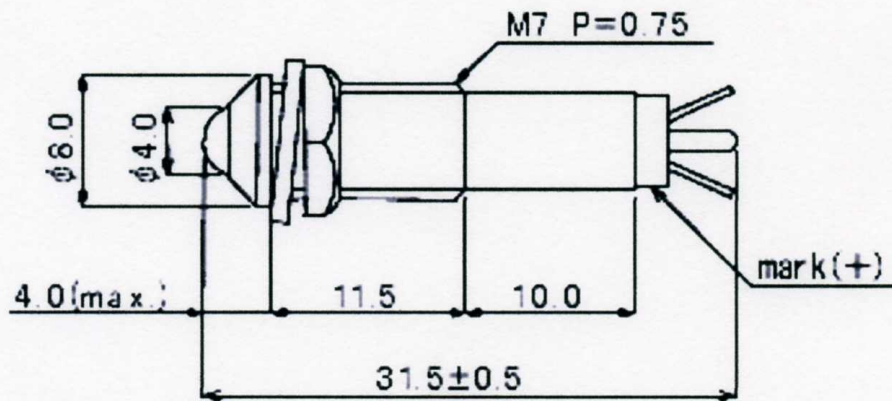

DATA	
Material of Body	Polycarbonate w/PC Lens
Color (LED)	Red, Green, Orange, Blue, White
Lens	White
Voltage	12V, 24V
Voltage Breakdown	AC 1,000V / minute
Insulation Resistance	DC 500V 100MOhm or more
Operating Temperature	-20°C ~ +75°C
Terminals	Solder Terminal
Thread	$\phi 7.00$ mm X L 11.5mm Pitch = 0.75mm
Mounting Hole (Recommended)	$\phi 7.2$ mm