

A B C D E F G H

1  
2  
3  
4  
5  
6

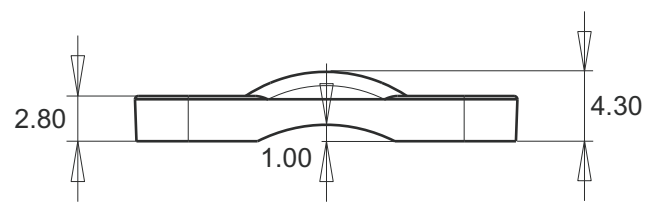
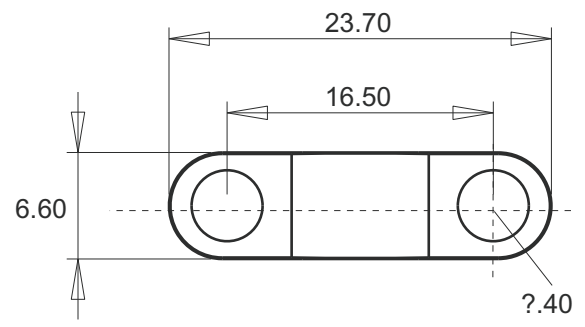
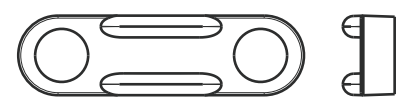
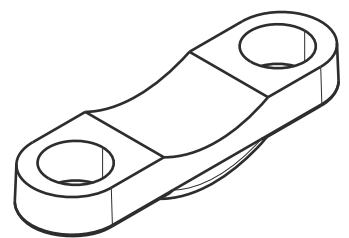
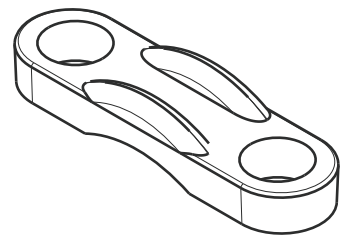

				Material/Color	Nylon 66 / Black	
DATE	REVISION	APPROVAL BY	DIMENSION	mm ?.2	Model no.	WCC-165BK-25S
			DRAW BY	John	Product	Plastic wire clips
			APPROVAL BY	Gary		
			DATE	02-12-2015		

A B C D E F G H

1  
2  
3  
4  
5  
6

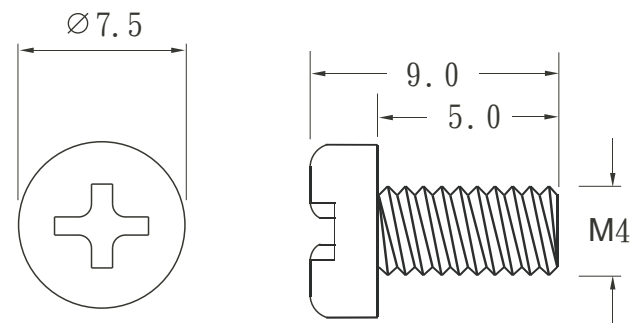

				Material /Color	Nylon 66 / Black	
DATE	REVISION	APPROVAL BY	DIMENSION	mm±0.2	PART No	WCC-165BK-25S
23-06-2016	up-dated screw length	C. CHOY	DRAW BY	John	NAME	PLASTIC SCREW
			APPROVAL BY	Gary		
			DATE	10-12-2015		