

ASMT-Mx6x & ASMT-MxHx

½W Power LED Light Source



Data Sheet



Description

½W Power LED Light Source is a high performance energy efficient device which can handle high thermal and high driving current. The exposed pad design has excellent heat transfer from the package to the motherboard. Option with electrically isolated metal slug is also available

The Cool White Power LED is available in various color temperature ranging from 4000K to 10000K and Warm White Power LED ranging from 2600K to 4000K.

The low profile package design is suitable for a wide variety of applications especially where height is a constraint.

The package is compatible with reflow soldering. This will give more freedom and flexibility to the light source designer.

Applications

- Sign backlight
- Safety, exit and emergency sign lightings
- Specialty lighting such as task lighting and reading lights
- Retail display
- Commercial lighting
- Accent or marker lightings, strip or step lightings

Features

- Available in Cool White and Warm White color
- Available in diffuse and non-diffuse version
- Available in both electrical isolated and non-isolated metal slug
- Energy efficient
- Exposed pad for excellent heat transfer
- Suitable for reflow soldering process
- High current operation
- Long operation life
- Wide viewing angle
- Silicone encapsulation
- ESD HBM Class 3B, > 8000
- MSL 4 products
- High junction temperature of 145°C

Specifications

- InGaN Technology
- 3.5V, 150mA (typical)
- 110 viewing angle

Package Dimensions

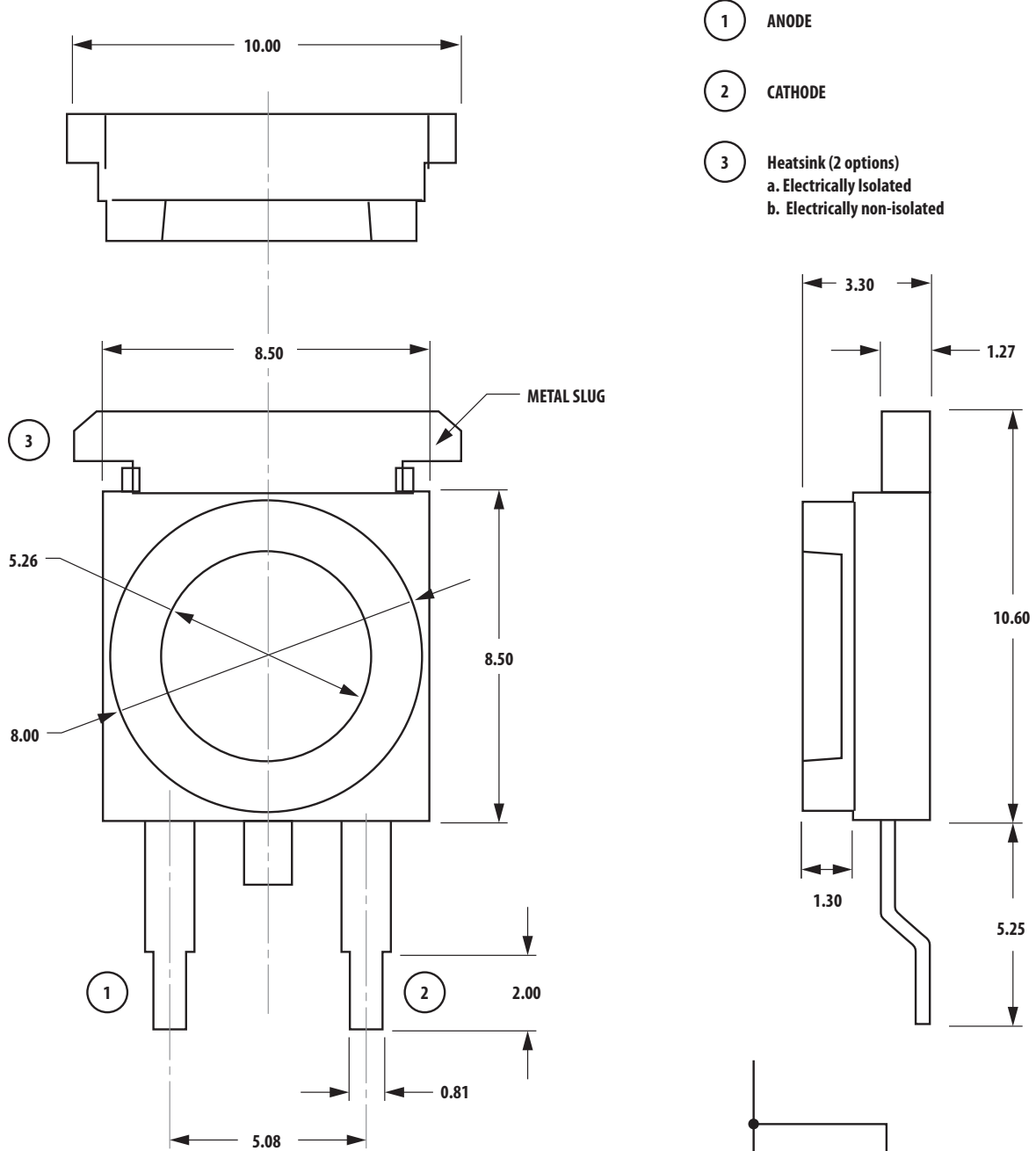

- Notes:
1. All dimensions in millimeters.
 2. Tolerance is ± 0.1 mm unless otherwise specified.

Device Selection Guide at Junction Temperature $T_j = 25^\circ\text{C}$

Color	Part Number	Luminous Flux, $\Phi_v^{[1,2]}$ (lm)			Test Current (mA)	Metal Slug	Dice Technology
		Min	Typ	Max			
Cool White	ASMT-MW60	19.5	30	43.0	150	Non-isolated	InGaN
Warm White	ASMT-MY60	15	25	33	150	Non-isolated	InGaN
Cool White Diffuse	ASMT-MWH0	15	25	43.0	150	Non-isolated	InGaN
Warm White Diffuse	ASMT-MYH0	11.5	20	33	150	Non-isolated	InGaN
Cool White	ASMT-MW62	19.5	30	43.0	150	Isolated	InGaN
Warm White	ASMT-MY62	15	25	33	150	Isolated	InGaN
Cool White Diffuse	ASMT-MWH2	15	25	43.0	150	Isolated	InGaN
Warm White Diffuse	ASMT-MYH2	11.5	20	33	150	Isolated	InGaN

Notes:

- Φ_v is the total luminous flux output as measured with an integrating sphere at 25ms mono pulse condition.
- Flux tolerance is $\pm 10\%$

Part Numbering System

ASMT – M x x x – N x₁ x₂ x₃ x₄

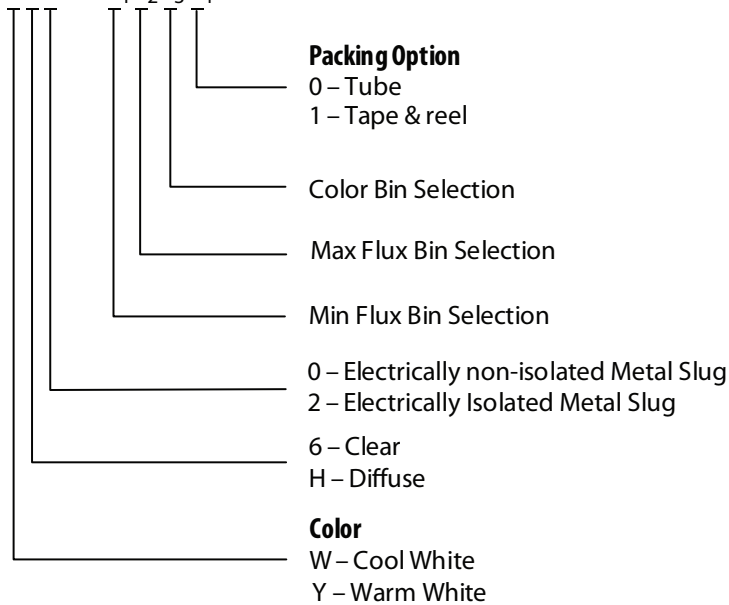

Absolute Maximum Ratings at T_A = 25°C

Parameter	ASMT-Mx60	Units
DC Forward Current [1]	150	mA
Peak Pulsing Current [2]	300	mA
Power Dissipation	525	mW
LED Junction Temperature	145	°C
Operating Ambient Temperature Range	-40 to +120	°C
Storage Temperature Range	-40 to +120	°C

Notes:

1. DC forward current – derate linearly based on Figure 5.
2. Pulse condition duty factor = 10%, Frequency = 1kHz

Optical Characteristics (T_A = 25°C)

Part Number	Color	Correlated Color Temperature, CCT (Kelvin)		Viewing Angle 2θ _{1/2} [1]	Luminous Efficiency
		Min	Max	(Degrees)	(lm/W)
ASMT-MW6x	Cool White	4000	10000	Typ	Typ
ASMT-MY6x	Warm White	2600	4000	110	57
ASMT-MWHx	Cool White Diffuse	4000	10000	110	48
ASMT-MYHx	Warm White Diffuse	2600	4000	120	48
				120	38

Notes:

1. θ_{1/2} is the off-axis angle where the luminous intensity is 1/2 the peak intensity.

Electrical Characteristic (T_A = 25°C)

Dice Type	Forward Voltage V _F (Volts) @ I _F = 150mA		Reverse Voltage V _R (Volts)	Thermal Resistance R _{θj-ms} (°C/W)[1]
	Typ.	Max.	Max.	Typ.
InGaN	3.5	4.0	5	27

Note:

1. R_{θj-ms} is Thermal Resistance from LED junction to metal slug.

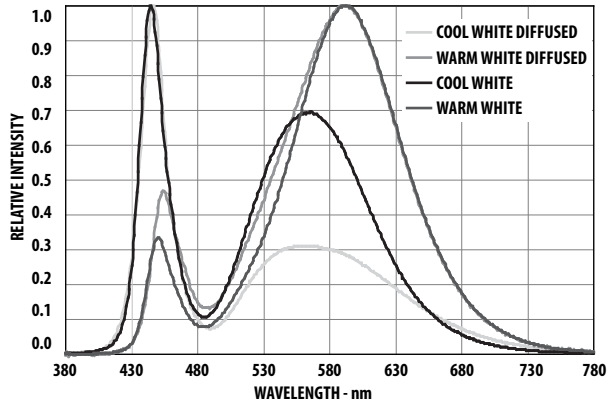

Figure 1. Relative Intensity vs. Wavelength

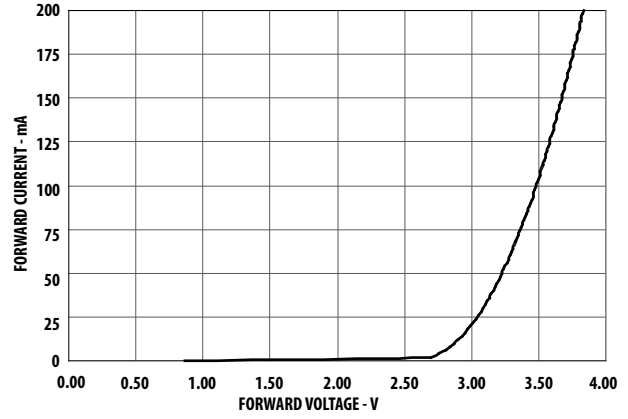

Figure 2. Forward Current vs Forward Voltage

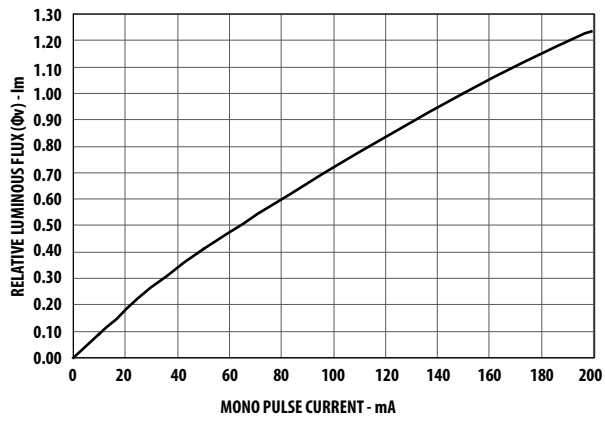

Figure 3. Relative Luminous Flux vs. Mono Pulse Current

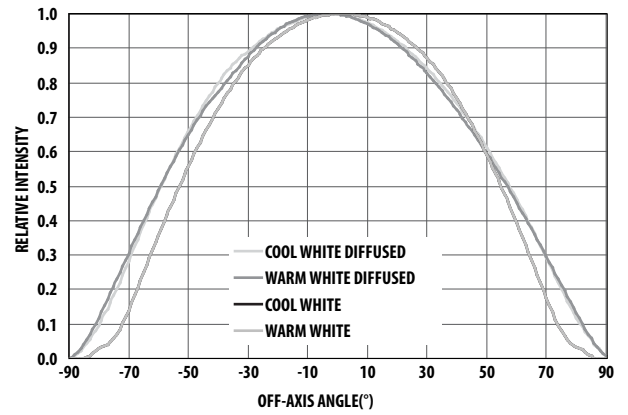

Figure 4. Radiation Pattern

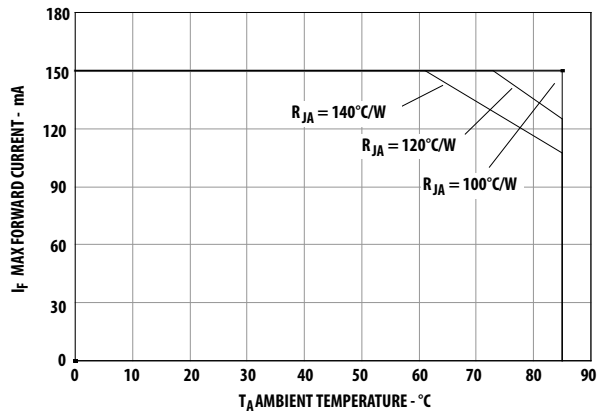

Figure 5. Maximum forward current vs. ambient temperature. Derated based on $T_{JMAX} = 145^\circ\text{C}$, $R_{\theta JA} = 100^\circ\text{C/W}$, 120°C/W and 140°C/W

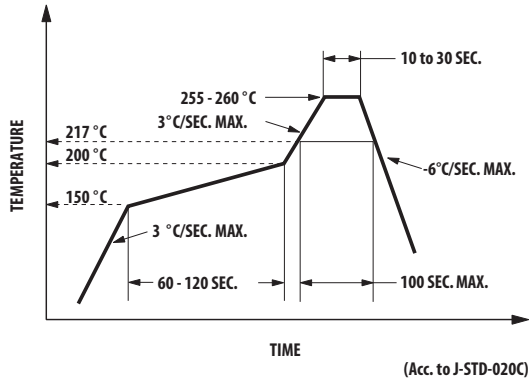

Figure 6. Recommended Reflow Soldering

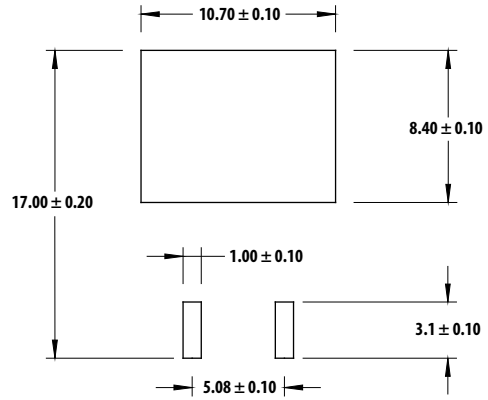

Figure 7. Recommended soldering land pattern

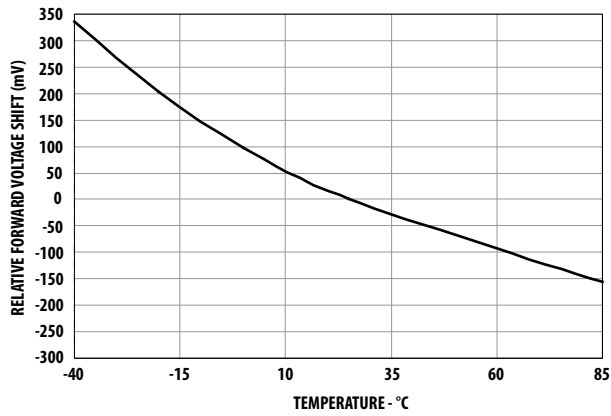

Figure 8. Temperature vs. relative forward voltage shift

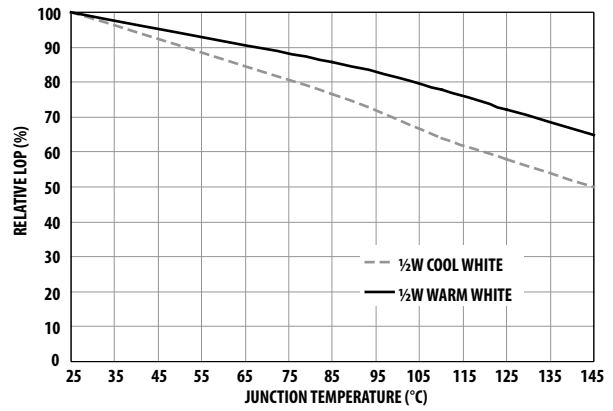

Figure 9. Relative LOP vs Junction Temperature for InGaN Devices

Flux Bin Limit^[1] (For reference only) [X₁ X₂]

Bin	Flux (lm) at 150mA	
	Min	Max
A	5.5	7.0
B	7.0	9.0
C	9.0	11.5
D	11.5	15.0
E	15.0	19.5
F	19.5	25.5
G	25.5	33.0
H	33.0	43.0

Tolerance for each bin limits is ±10 %

Color Bin Selections [X₃]

Individual reel will contain parts from one full bin only.

Cool White	
O	Full Distribution
A	A only
B	B only
C	C only
D	D only
E	E only
F	F only
G	G only
H	H only
Z	A and B only
Y	B and C only
W	C and D only
V	D and E only
U	E and F only
T	F and G only
S	G and H only
Q	A, B and C only
P	B, C and D only
N	C, D and E only
M	D, E and F only
L	E, F and G only
K	F, G and H only
J	Special Color Bin
1	A, B, C and D only
2	E, F, G and H only
3	B, C, D and E only
4	C, D, E and F only
5	A, B, C, D and E only
6	B, C, D, E, and F only

Warm White	
O	Full Distribution
A	A only
B	B only
C	C only
D	D only
E	E only
F	F only
Z	A and B only
Y	B and C only
W	C and D only
V	D and E only
U	E and F only
Q	A, B and C only
P	B, C and D only
N	C, D and E only
M	D, E and F only
J	Special Color Bin
1	A, B, C and D only
2	E, F, G and H only
3	B, C, D and E only
4	C, D, E and F only
5	A, B, C, D and E only
6	B, C, D, E, and F only

Primary Color Binning

Cool White	Color Limits (Chromaticity Coordinates)				
Bin A	X	0.367	0.362	0.329	0.329
	Y	0.400	0.372	0.345	0.369
Bin B	X	0.362	0.356	0.329	0.329
	Y	0.372	0.330	0.302	0.302
Bin C	X	0.329	0.329	0.305	0.301
	Y	0.369	0.345	0.322	0.342
Bin D	X	0.329	0.329	0.311	0.305
	Y	0.345	0.302	0.285	0.322
Bin E	X	0.303	0.307	0.283	0.274
	Y	0.333	0.311	0.284	0.301
Bin F	X	0.307	0.311	0.290	0.283
	Y	0.311	0.285	0.265	0.284
Bin G	X	0.388	0.379	0.362	0.367
	Y	0.417	0.383	0.372	0.400
Bin H	X	0.379	0.369	0.356	0.362
	Y	0.383	0.343	0.330	0.372

Tolerances ± 0.01

Warm White	Color Limits (Chromaticity Coordinates)				
Bin A	X	0.452	0.488	0.470	0.438
	Y	0.434	0.447	0.414	0.403
Bin B	X	0.438	0.470	0.452	0.424
	Y	0.403	0.414	0.384	0.376
Bin C	X	0.407	0.418	0.452	0.438
	Y	0.393	0.422	0.434	0.403
Bin D	X	0.395	0.407	0.438	0.424
	Y	0.362	0.393	0.403	0.376
Bin E	X	0.381	0.387	0.418	0.407
	Y	0.377	0.404	0.422	0.393
Bin F	X	0.373	0.381	0.407	0.395
	Y	0.349	0.377	0.393	0.362

Tolerances ± 0.01

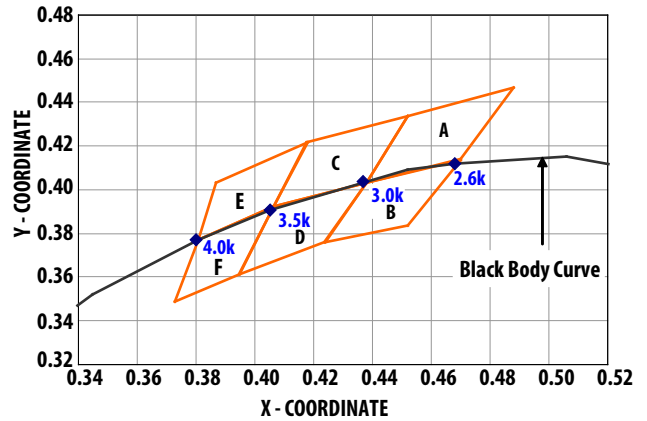
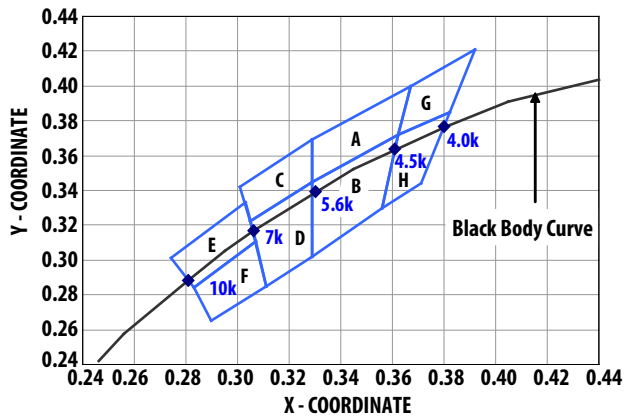

Sub-Color Binning

(Only Applicable for Color Bin A to Bin D and Bin G to Bin H)

Color Limits

Cool White	Color Limits (Chromaticity Coordinates)				
Bin A1	X	0.364	0.367	0.348	0.347
	Y	0.383	0.400	0.385	0.372
Bin A2	X	0.364	0.362	0.346	0.347
	Y	0.383	0.372	0.359	0.372
Bin A3	X	0.329	0.329	0.348	0.347
	Y	0.357	0.369	0.385	0.372
Bin A4	X	0.329	0.329	0.347	0.346
	Y	0.345	0.357	0.372	0.359
Bin B1	X	0.362	0.360	0.344	0.346
	Y	0.372	0.357	0.344	0.359
Bin B2	X	0.360	0.358	0.343	0.344
	Y	0.357	0.343	0.331	0.344
Bin B3	X	0.358	0.356	0.341	0.343
	Y	0.343	0.330	0.314	0.331
Bin B4	X	0.329	0.329	0.346	0.344
	Y	0.331	0.345	0.359	0.344
Bin B5	X	0.329	0.344	0.343	0.329
	Y	0.331	0.344	0.331	0.320
Bin B6	X	0.343	0.341	0.329	0.329
	Y	0.331	0.314	0.302	0.320
Bin C1	X	0.329	0.329	0.315	0.314
	Y	0.369	0.357	0.344	0.355
Bin C2	X	0.329	0.329	0.316	0.315
	Y	0.357	0.345	0.333	0.344
Bin C3	X	0.314	0.315	0.303	0.301
	Y	0.355	0.344	0.333	0.342
Bin C4	X	0.315	0.316	0.305	0.303
	Y	0.344	0.333	0.322	0.333

Cool White	Color Limits (Chromaticity Coordinates)				
Bin D1	X	0.329	0.329	0.317	0.316
	Y	0.345	0.331	0.320	0.333
Bin D2	X	0.329	0.329	0.318	0.317
	Y	0.331	0.320	0.310	0.320
Bin D3	X	0.329	0.329	0.320	0.318
	Y	0.320	0.302	0.293	0.310
Bin D4	X	0.316	0.317	0.307	0.305
	Y	0.333	0.320	0.311	0.322
Bin D5	X	0.317	0.318	0.309	0.307
	Y	0.320	0.310	0.300	0.311
Bin D6	X	0.318	0.320	0.311	0.309
	Y	0.310	0.293	0.285	0.300
Bin G1	X	0.392	0.386	0.364	0.367
	Y	0.421	0.400	0.383	0.400
Bin G2	X	0.386	0.382	0.362	0.364
	Y	0.400	0.385	0.372	0.383
Bin H1	X	0.382	0.378	0.360	0.362
	Y	0.385	0.370	0.357	0.372
Bin H2	X	0.378	0.375	0.358	0.360
	Y	0.370	0.358	0.343	0.357
Bin H3	X	0.375	0.371	0.356	0.358
	Y	0.358	0.344	0.330	0.343

Tolerances ± 0.01

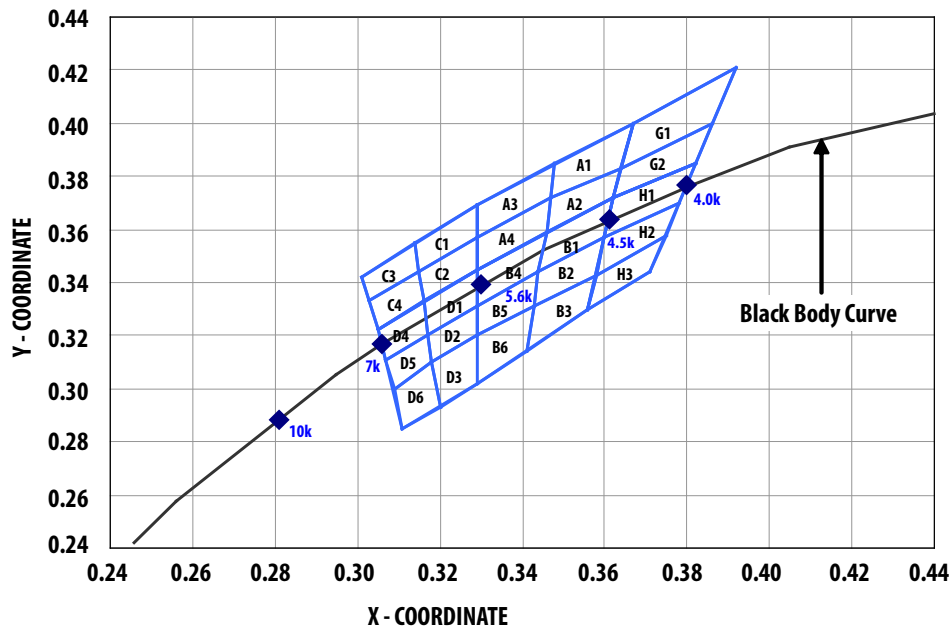

Package Tube – Option 0

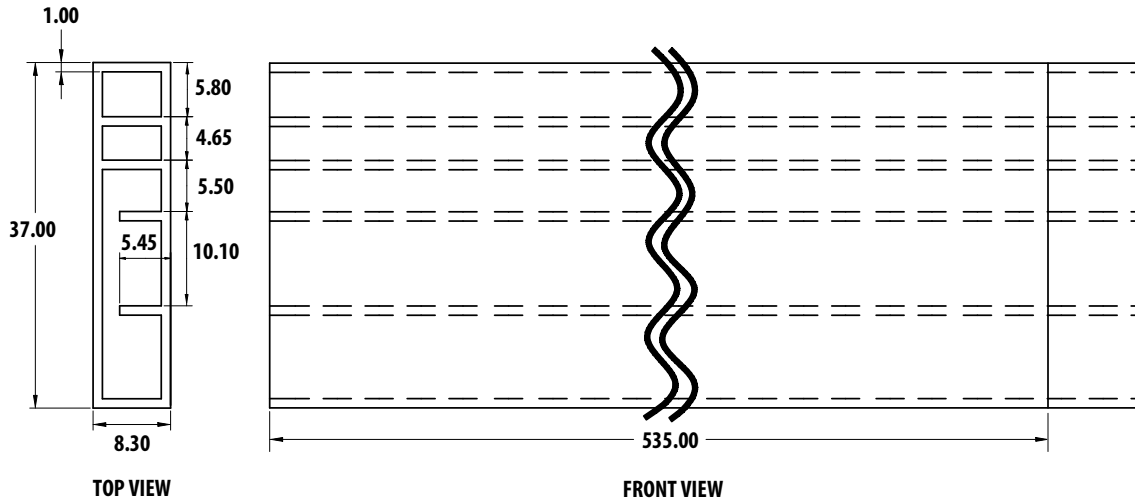

Tape & Reel – Option 1

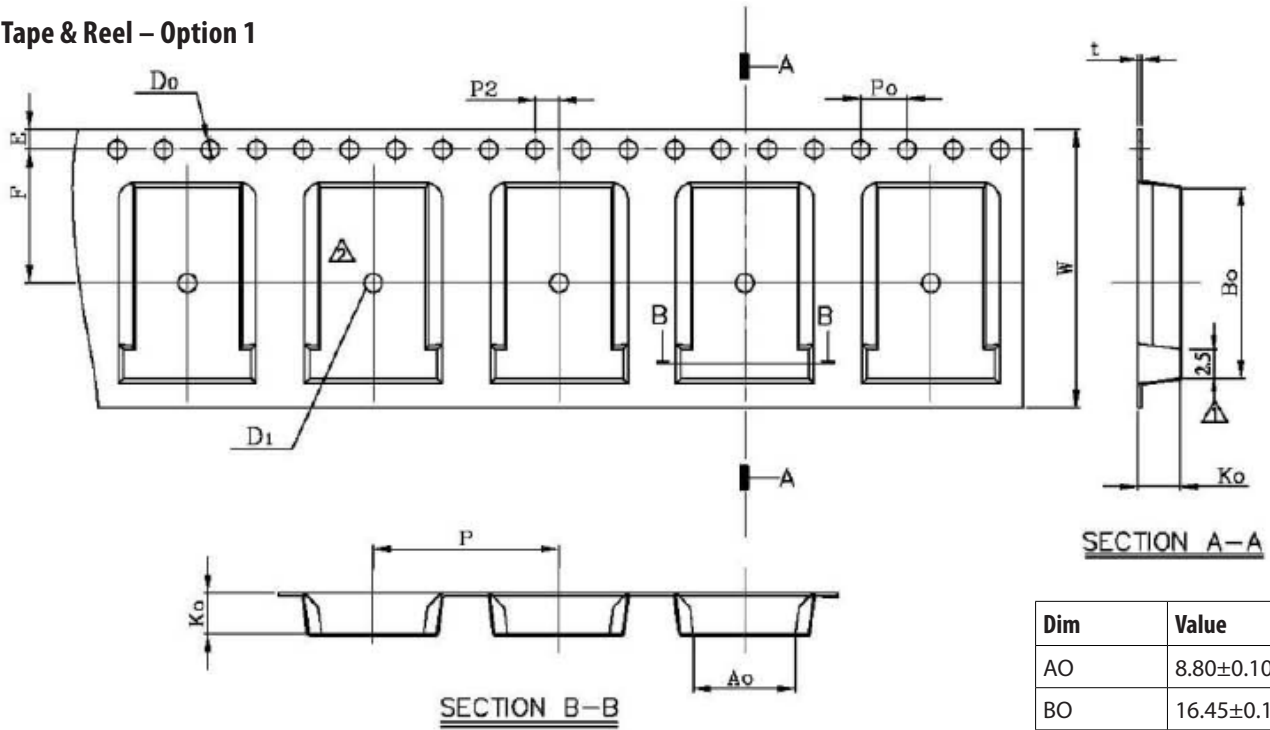

Dim	Value
AO	8.80±0.10
BO	16.45±0.10
KO	3.60±0.10
W	24.0±0.10
P	16.0±0.10
Qty/Reel	250EA

Unit: mm

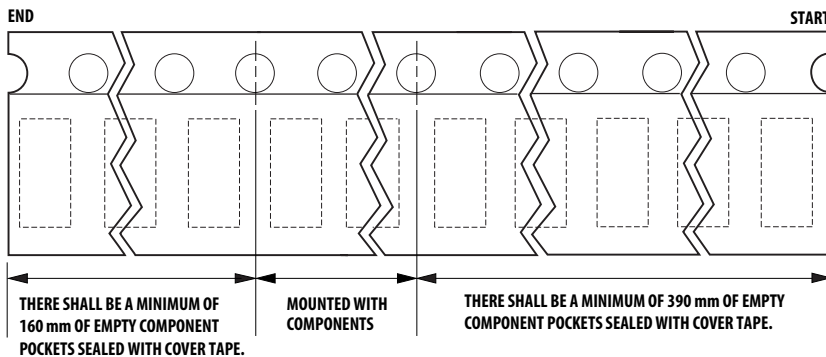

Reel Dimension

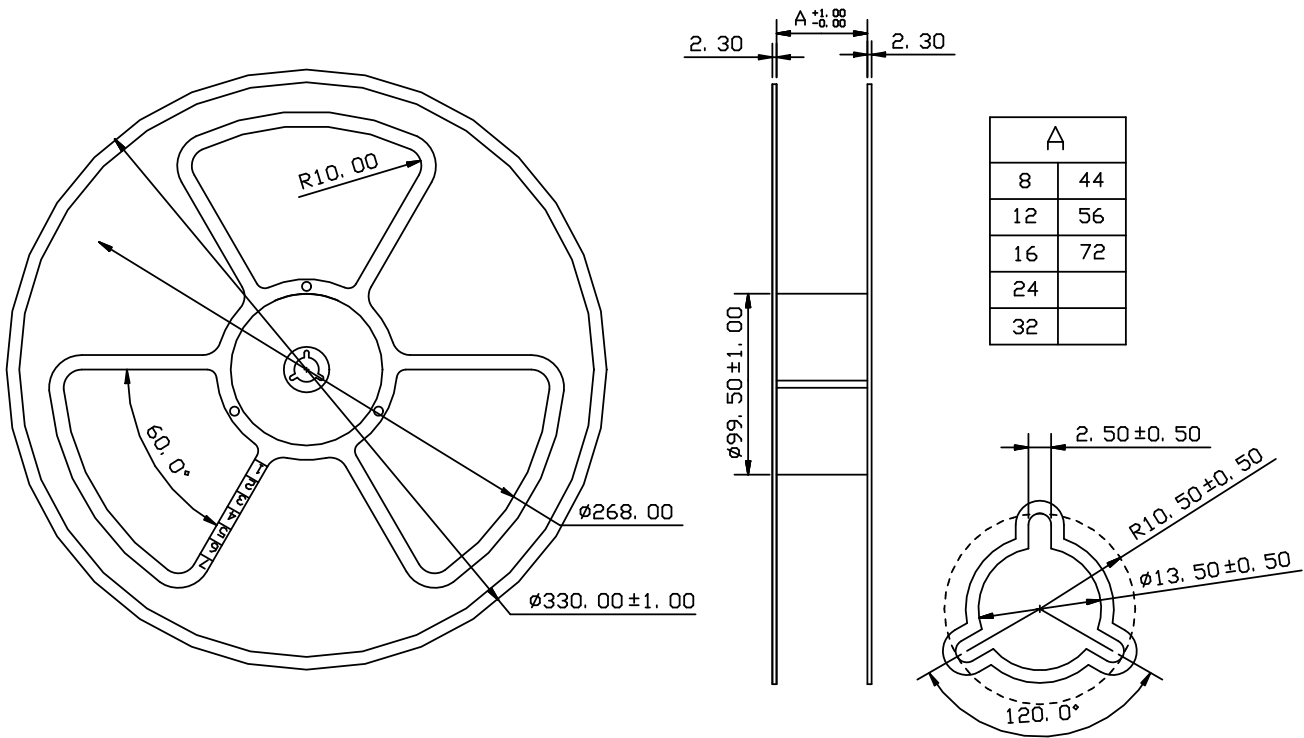

Handling Precaution:

The encapsulation material of the product is made of silicone for better reliability of the product. As silicone is a soft material, please do not press on the silicone or poke a sharp object onto the silicone. These might damage the

product and cause premature failure. During assembly or handling, the unit should be held on the body (white epoxy).

DISCLAIMER: AVAGO'S PRODUCTS AND SOFTWARE ARE NOT SPECIFICALLY DESIGNED, MANUFACTURED OR AUTHORIZED FOR SALE AS PARTS, COMPONENTS OR ASSEMBLIES FOR THE PLANNING, CONSTRUCTION, MAINTENANCE OR DIRECT OPERATION OF A NUCLEAR FACILITY OR FOR USE IN MEDICAL DEVICES OR APPLICATIONS. CUSTOMER IS SOLELY RESPONSIBLE, AND WAIVES ALL RIGHTS TO MAKE CLAIMS AGAINST AVAGO OR ITS SUPPLIERS, FOR ALL LOSS, DAMAGE, EXPENSE OR LIABILITY IN CONNECTION WITH SUCH USE.

For product information and a complete list of distributors, please go to our web site: www.avagotech.com

Avago, Avago Technologies, and the A logo are trademarks of Avago Technologies Limited in the United States and other countries. Data subject to change. Copyright © 2005-2008 Avago Technologies Limited. All rights reserved. AV02-1319EN - June 16, 2008

AVAGO
TECHNOLOGIES