

Mini DomiLEDTM

With the intense colors that seem to glow with energy and its significant brightness, Mini DomiLEDTM white LED is a highly reliable design device. Its dynamic nature makes it perfect choice for lighthing applications, office and home applications and standard industrial applications.



Features:

- > High brightness surface mount LED.
- > Based on InGaN technology.
- > 120° viewing angle.
- > Small package outline (LxWxH) of 2.0 x 1.4 x 1.3mm.
- > Qualified according to JEDEC moisture sensitivity Level 2.
- > Compatible to both IR reflow soldering.
- > Environmental friendly; RoHS compliance.



Applications:

- > Automotive: interior applications, eg: switches, telematics, climate control system, dashboard, etc.
- > Backlighting: button, LCD display



Optical Characteristics at Tj=25°C

Part Ordering Number	Chip Technology / Color	Viewing Angle°	Luminous Intensity @ IF = 20mA IV (mcd)
DNW-UJG-TU2-1	InGaN	120	285.0 - 355.0
• DNW-UJG-T1	White		285.0 - 355.0
• DNW-UJD-T2			355.0 - 450.0
• DNW-UJD-U1			450.0 - 560.0
• DNW-UJD-U2			560.0 - 715.0
DNW-UJG-UV2-1			450.0 - 1125.0
• DNW-UJG-U1			450.0 - 560.0
• DNW-UJG-U2			560.0 - 715.0
• DNW-UJG-V1			715.0 - 900.0
• DNW-UJG-V2			900.0 - 1125.0

NOTE

1. All part number above comes in a quantity of 3000 units per reel.
2. Other luminous intensity groups are also available upon request.
3. Luminous intensity is measured with an accuracy of ± 11%.
4. Color binning is carried for all units as per the color binning table. Only one color group is allowed for each reel.

Electrical Characteristics at Tj=25°C

Part Number	Vf @ If = 20 mA			Vr @ Ir = 10 µA
	Min. (V)	Typ. (V)	Max. (V)	Min. (V)
DNW-UJG	2.9	3.2	3.8	5.0

Forward Voltage, Vf is measured with an accuracy of ± 0.1 V.

Material

Material	
Lead-frame	Cu Alloy With Ag Plating
Package	High Temperature Resistant Plastic, PPA
Encapsulant	Epoxy
Soldering Leads	Sn-Sn Plating

Absolute Maximum Ratings

	Maximum Value	Unit
DC forward current	20	mA
Peak pulse current; (tp ≤ 10μs, Duty cycle = 0.005)	200	mA
Reverse voltage	5	V
ESD threshold (HBM)	2000	V
LED junction temperature	125	°C
Operating temperature	-40 ... +100	°C
Storage temperature	-40 ... +100	°C
Power dissipation (at room temperature)	85	mW

DNW, White Color Grouping

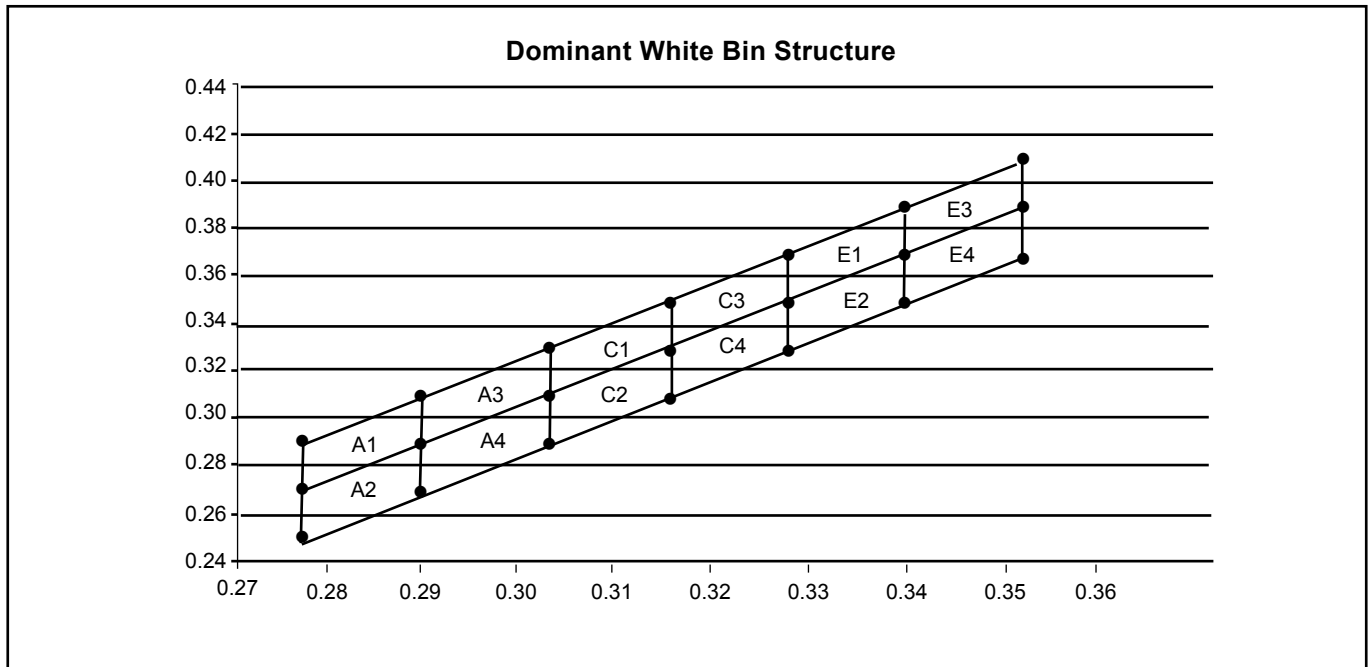

Chromaticity coordinate groups are measured with an accuracy of ± 0.01 .

Bin					
A1	Cx	0.2775	0.2900	0.2900	0.2775
	Cy	0.2732	0.2939	0.3114	0.2907
A2	Cx	0.2775	0.2900	0.2900	0.2775
	Cy	0.2557	0.2764	0.2939	0.2732
A3	Cx	0.2900	0.3025	0.3025	0.2900
	Cy	0.2939	0.3146	0.3321	0.3114
A4	Cx	0.2900	0.3025	0.3025	0.2900
	Cy	0.2764	0.2971	0.3146	0.2939
C1	Cx	0.3025	0.3150	0.3150	0.3025
	Cy	0.3146	0.3354	0.3529	0.3321
C2	Cx	0.3025	0.3150	0.3150	0.3025
	Cy	0.2971	0.3179	0.3354	0.3146
C3	Cx	0.3150	0.3275	0.3275	0.3150
	Cy	0.3354	0.3561	0.3736	0.3529
C4	Cx	0.3150	0.3275	0.3275	0.3150
	Cy	0.3179	0.3386	0.3561	0.3354

Bin					
E1	Cx	0.3275	0.3400	0.3400	0.3275
	Cy	0.3561	0.3768	0.3943	0.3736
E2	Cx	0.3275	0.3400	0.3400	0.3275
	Cy	0.3386	0.3593	0.3768	0.3561
E3	Cx	0.3400	0.3525	0.3525	0.3400
	Cy	0.3768	0.3975	0.4150	0.3943
E4	Cx	0.3400	0.3525	0.3525	0.3400
	Cy	0.3593	0.3800	0.3975	0.3768

Dominant color coordinate is measured with an accuracy of ± 0.01 .

Relative Luminous Intensity Vs Forward Current

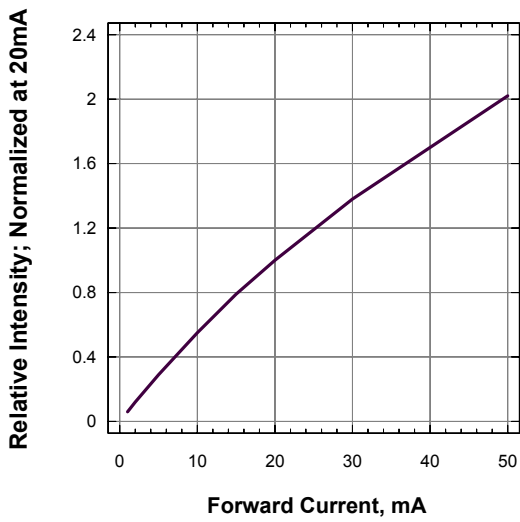

Forward Current Vs Forward Voltage

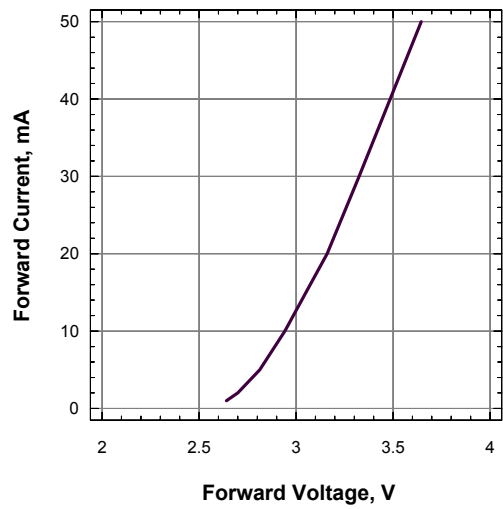

Maximum Current Vs Ambient Temperature

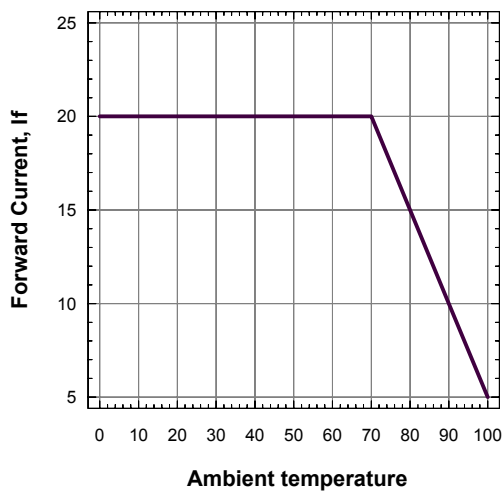

Relative Intensity Vs. Wavelength

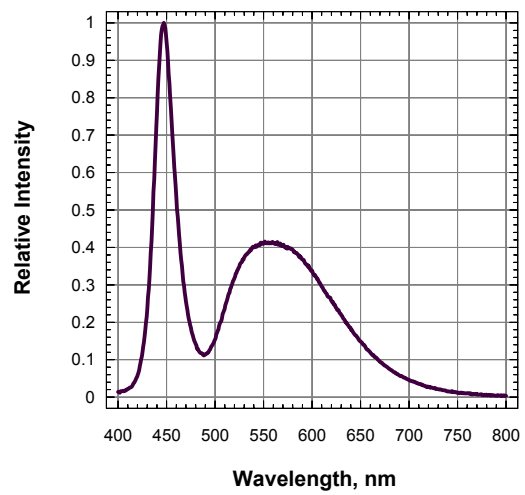

Radiation Pattern

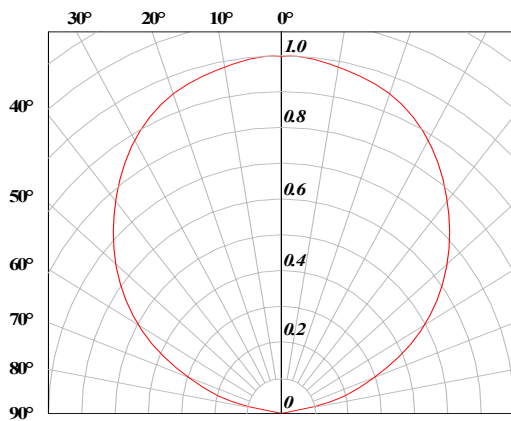

Mini DomiLED™ • InGaN White : DNW-UJG Package Outlines

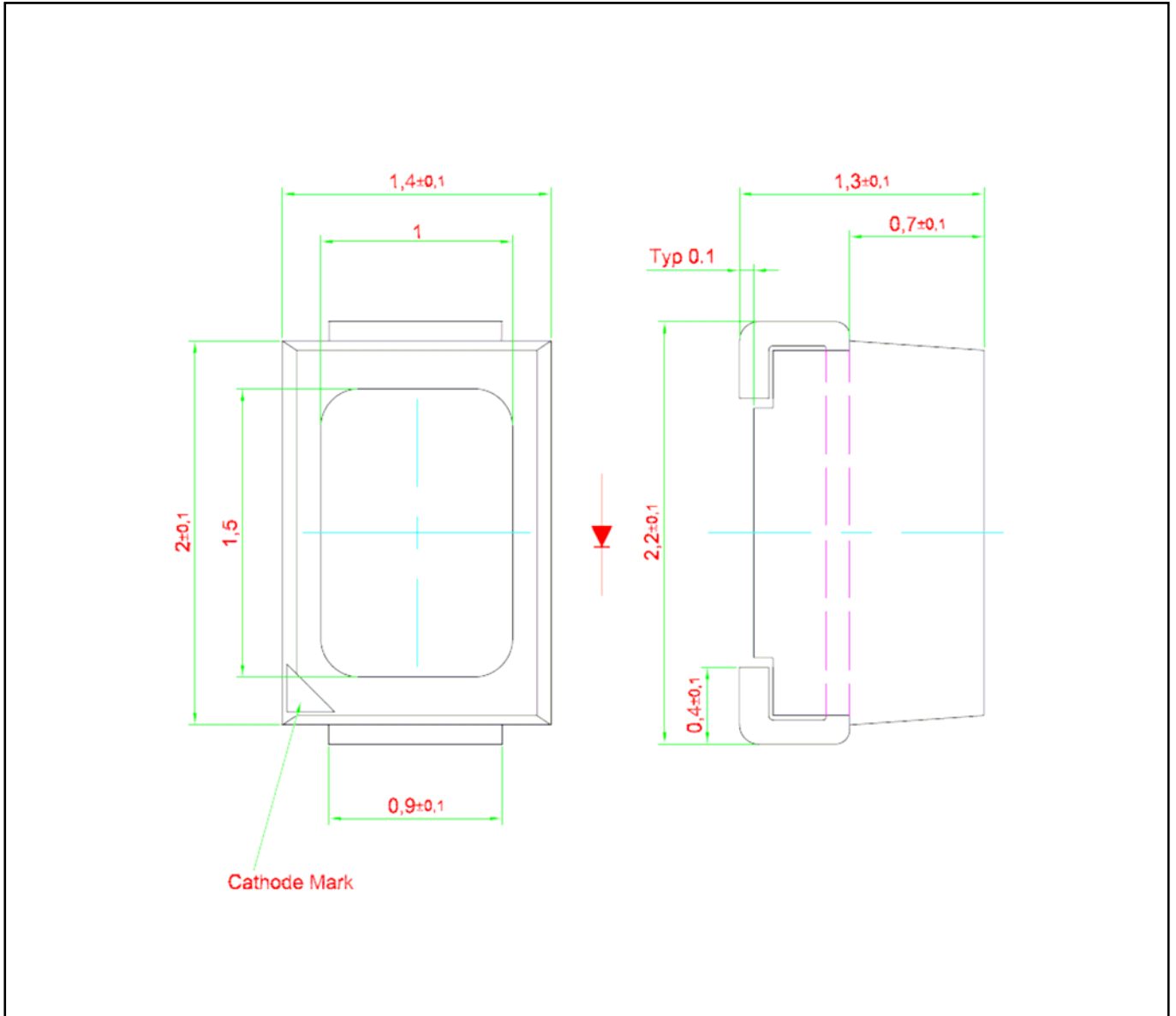

Recommended Solder Pad

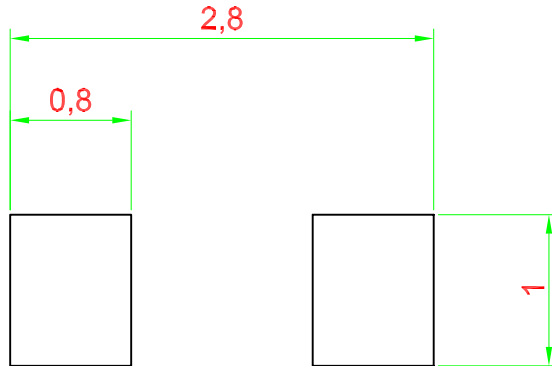

Improved Design For Better Heat Dissipation

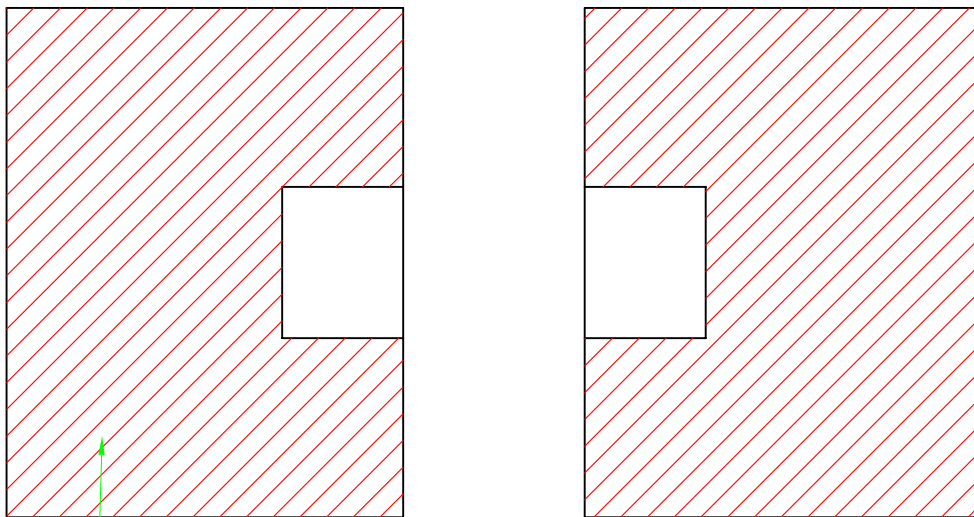

Additional Cu area for improved heat dissipation, > 16mm sq.

 Solder resist.

Taping and orientation

- Reels come in quantity of 3000 units.
- Reel diameter is 180 mm.

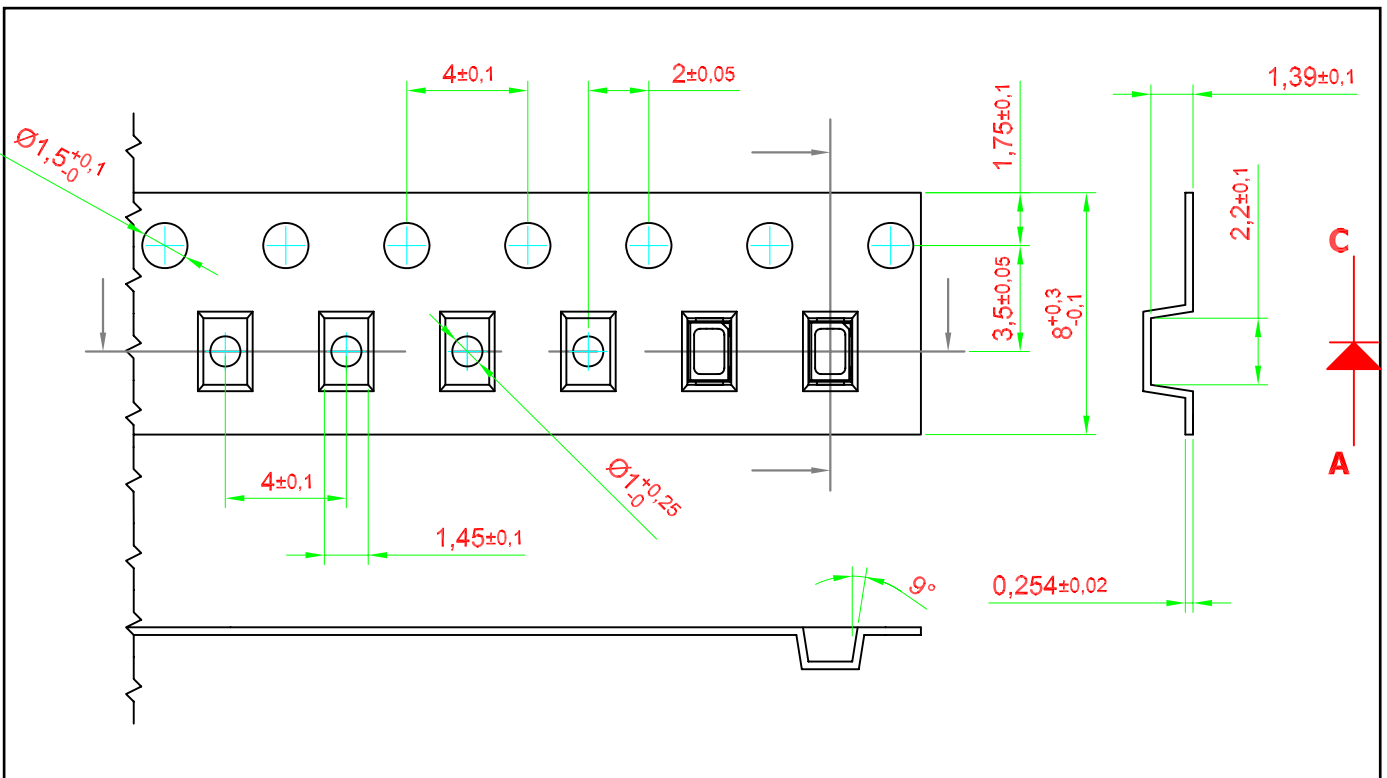

Packaging Specification

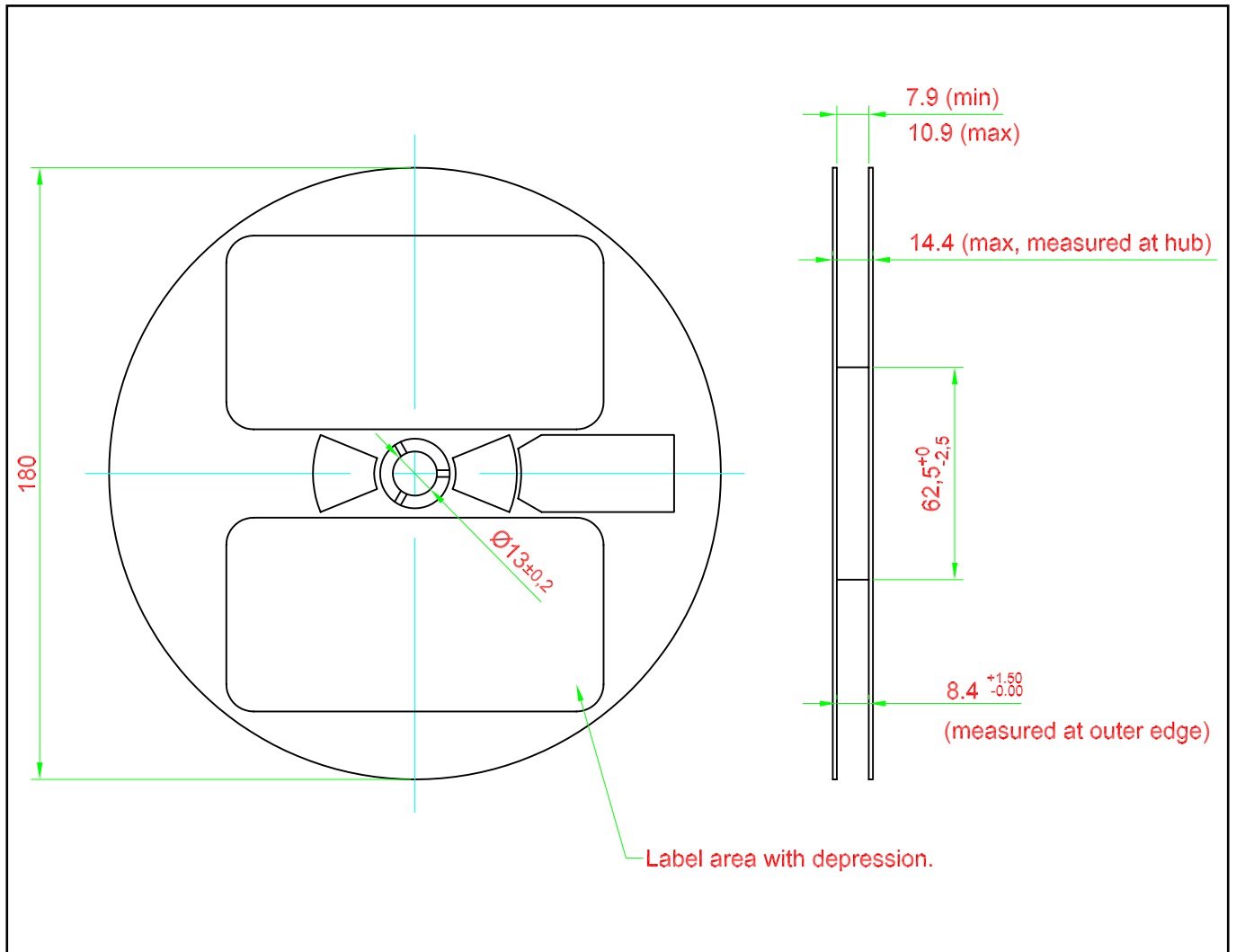

Packaging Specification

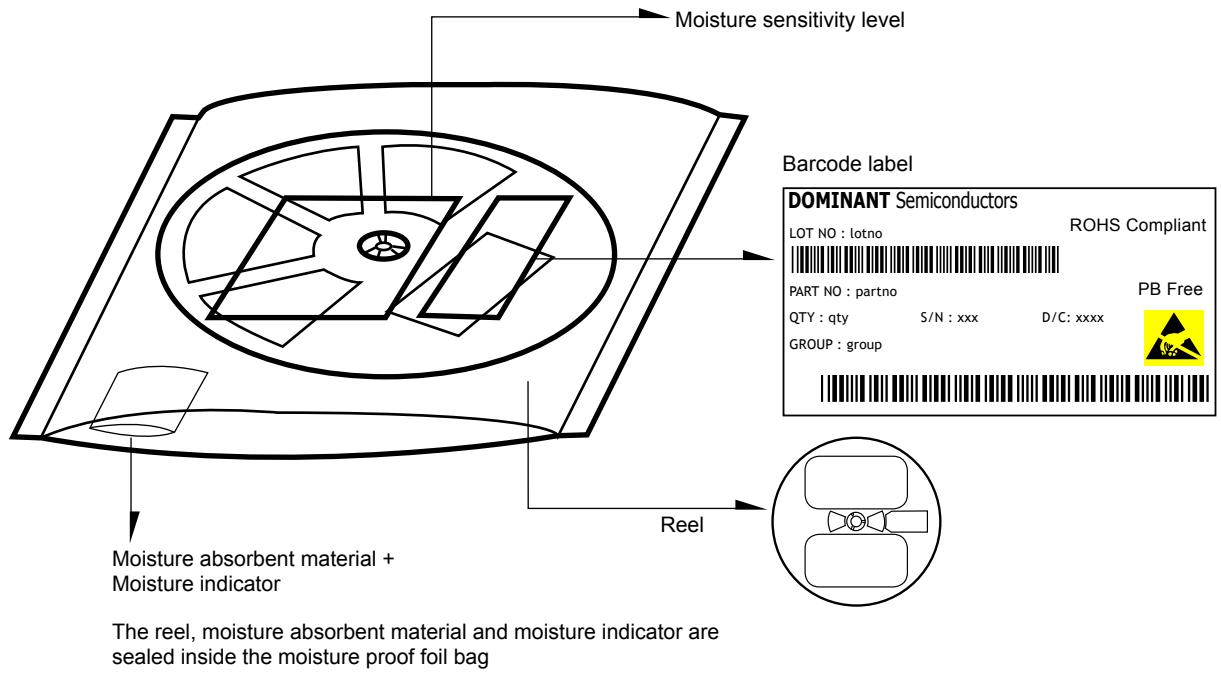

	Average 1pc Mini DomiLED	1 completed bag (3000pcs)
Weight (gram)	0.007	140 ± 10

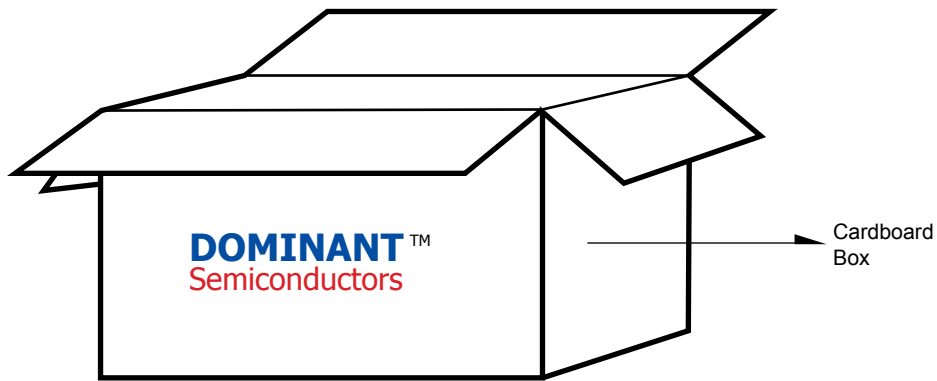

For Mini DomiLED™

Cardboard Box Size	Dimensions (mm)	Empty Box Weight (kg)	Reel / Box	Quantity / Box (pcs)
Small	300 x 250 x 250	0.58	15 reels MAX	45,000 MAX
Large	416 x 516 x 476	1.74	55 reels MAX	165,000 MAX

Recommended Sn-Pb IR-Reflow Soldering Profile

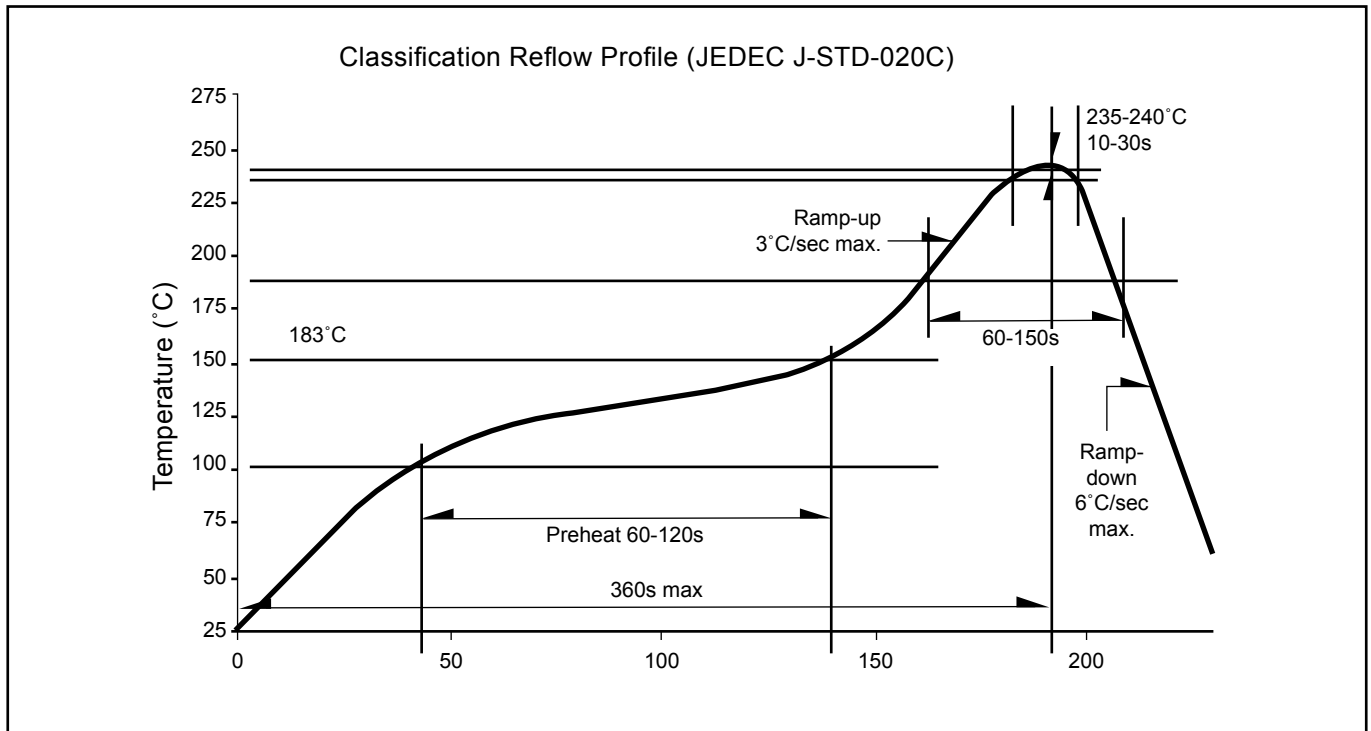

Recommended Pb-free Soldering Profile

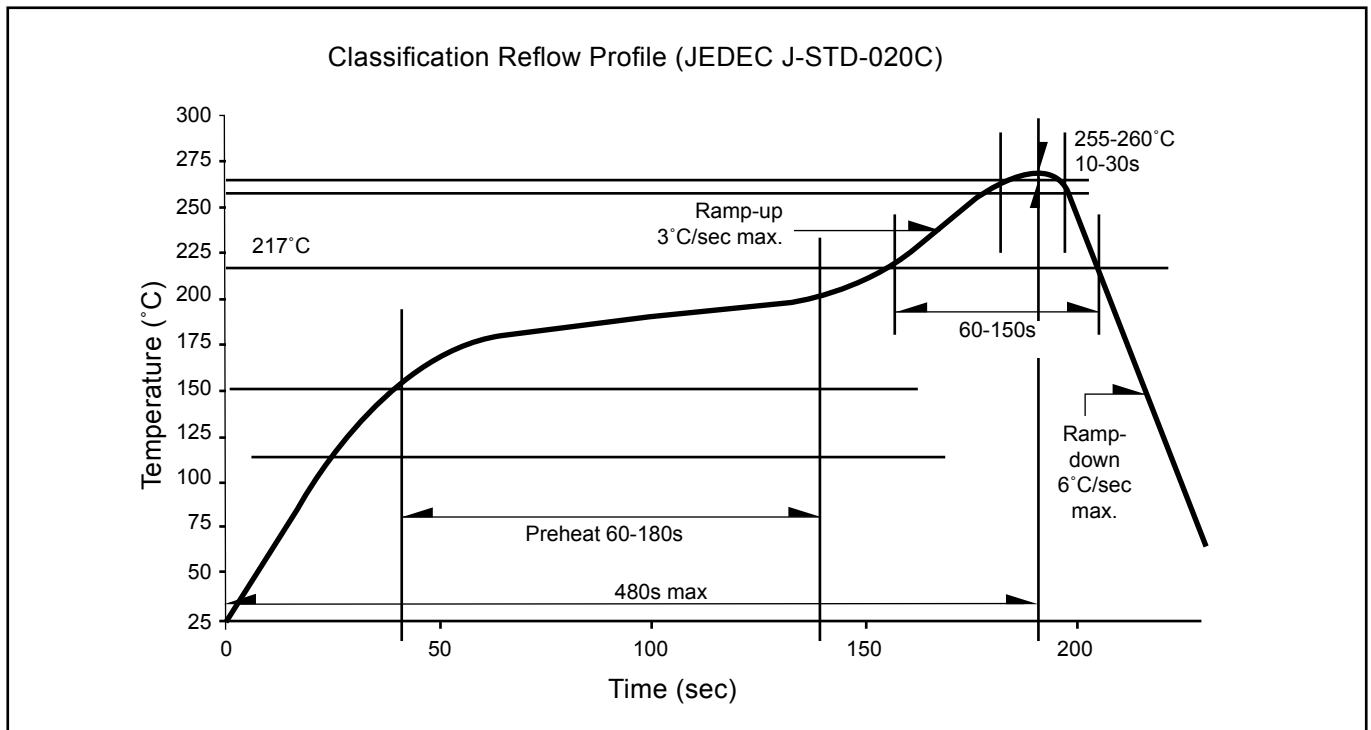

Revision History

Page	Subjects	Date of Modification
-	Initial Release	04 Feb 2008

NOTE

All the information contained in this document is considered to be reliable at the time of publishing. However, DOMINANT Semiconductors does not assume any liability arising out of the application or use of any product described herein.

DOMINANT Semiconductors reserves the right to make changes at any time without prior notice to any products in order to improve reliability, function or design.

DOMINANT Semiconductors products are not authorized for use as critical components in life support devices or systems without the express written approval from the Managing Director of DOMINANT Semiconductors.

About Us

DOMINANT Semiconductors is a dynamic Malaysian Corporation that is among the world's leading SMT LED Manufacturers. An excellence – driven organization, it offers a comprehensive product range for diverse industries and applications. Featuring an internationally certified quality assurance acclaim, DOMINANT's extra bright LEDs are perfectly suited for various lighting applications in the automotive, consumer and communications as well as industrial sectors. With extensive industry experience and relentless pursuit of innovation, DOMINANT's state-of-art manufacturing, research and testing capabilities have become a trusted and reliable brand across the globe. More information about DOMINANT Semiconductors can be found on the Internet at <http://www.dominant-semi.com>.

Please contact us for more information:

Head Quarter

DOMINANT Semiconductors Sdn. Bhd.
Lot 6, Batu Berendam, FTZ Phase III, 75350 Melaka, Malaysia
Tel: (606) 283 3566 Fax: (606) 283 0566
E-mail: sales@dominant-semi.com

DOMINANT Semiconductors Malaysia Sdn. Bhd. Shanghai Representative Office

DOMINANT Semiconductors (Shenzhen) Co. Ltd.
Rm 1007, DaZhong Building, No. 1515 Zhong Shan (W) Rd, Shanghai, China 200235
Tel: +86 21 6428 6428 Fax: +86 21 6428 6880
E-mail: sales_china@dominant-semi.com

DOMINANT Korea Sales Office

DOMINANT Semiconductors Korea Inc.
#709, Yatap Leaders Bldg., 342-1 Yatap-dong, Bundang-gu, Seongnam-si, Gyeonggi-do, 463-828 Korea.
Tel: +82-31-701-5203 Fax: +82-31-701-5204
E-mail: sales_korea@dominant-semi.com

DOMINANT U.S.A Sales Office

25 Rockaway Road, 08833 Lebanon, New Jersey, USA
Tel: (908) 439-9930 Cell: (908) 343-5810 Fax: (908) 439-9929
E-mail: don.wendel@dominant-semi.com

DOMINANT Europe Sales Office

DOMINANT Semiconductors Europe GmbH
Raiffeisenstr. 38, 74906 Bad Rappenau Germany
Tel: +49 (0) 7264-89010-10 / +49 (0) 7264-89010-11 Cell: +49 173-6907370 / +49 173-6907751
Fax: +49 (0) 7264-89010-29
E-mail: gerd.wachno@dominant-semi.eu; hartmut.wettengl@dominant-semi.eu

DOMINANT India Sales Office

C-11, Vasanth Business Centre #86, TTK Road, Alwarpet Chennai - 600 018, INDIA
Tel: 91-44-42030616 / 516 Cell: 91-9444920537 Fax: 91-9444920616
E-mail: pravat.behera@dominant-semi.com

