

USB Experiment interface board

K8055

Specifications:

- 5 Digital inputs (0= ground, 1= open). On board test buttons provided.
- 2 Analog inputs with attenuation and amplification option. Internal test +5V provided.
- 8 Digital open collector output switches (max 50V/100mA). On board LED indication.
- 2 Analog outputs
 - × 0 to 5V, output resistance 1K Ω .
 - × PWM 0 to 100% open collector outputs
 - × max 100mA / 40V. On board LED indication.
- General conversion time: 20mS per command
- Power supply through USB approx. 70mA.
- Diagnostic software and communication DLL included

Minimum system:

- Pentium class CPU
- USB1.0 or higher connection
- Windows 98SE or higher (Win NT excluded)
- CD ROM player and Mouse

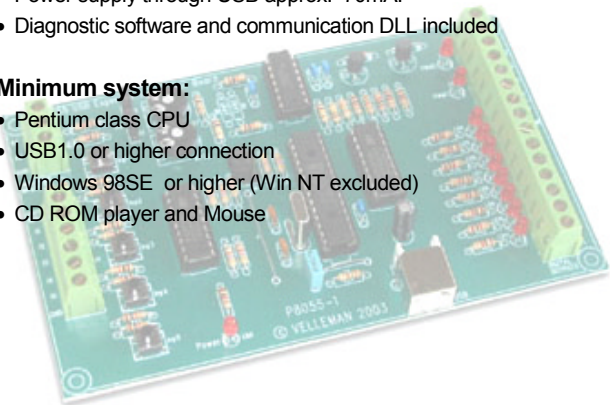

This device complies with Part 15 of the FCC Rules provided the enclosed instructions are followed to the letter. Use of the device is subject to the following conditions: (1) this device must not cause harmful interference and (2) the operation of this device should not be influenced by unwanted interference.

More information about FCC can be look at <http://www.fcc.gov>





VELLEMAN Components NV
Legen Heirweg 33
9890 Gavere
Belgium Europe
www.velleman.be
www.velleman-kit.com

1. Assembly (Skipping this can lead to troubles !)

Ok, so we have your attention. These hints will help you to make this project successful. Read them carefully.

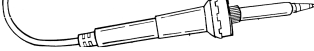
1.1 Make sure you have the right tools:

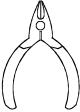
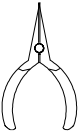
- A good quality soldering iron (25-40W) with a small tip. 
- Wipe it often on a wet sponge or cloth, to keep it clean; then apply solder to the tip, to give it a wet look. This is called 'thinning' and will protect the tip, and enables you to make good connections. When solder rolls off the tip, it needs cleaning.
- Thin rosin-core solder. Do not use any flux or grease. 
- A diagonal cutter to trim excess wires. To avoid injury when cutting excess leads, hold the lead so they cannot fly towards the eyes. 
- Needle nose pliers, for bending leads, or to hold components in place. 
- Small blade and Phillips screwdrivers. A basic range is fine.

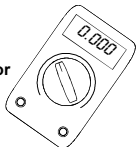

For some projects, a basic multi-meter is required, or might be handy

**1.2 Assembly Hints :**

- ⇒ Make sure the skill level matches your experience, to avoid disappointments.
- ⇒ Follow the instructions carefully. Read and understand the entire step before you perform each operation.
- ⇒ Perform the assembly in the correct order as stated in this manual
- ⇒ Position all parts on the PCB (Printed Circuit Board) as shown on the drawings.
- ⇒ Values on the circuit diagram are subject to changes.
- ⇒ Values in this assembly guide are correct*
- ⇒ Use the check-boxes to mark your progress.
- ⇒ Please read the included information on safety and customer service

* Typographical inaccuracies excluded. Always look for possible last minute manual updates, indicated as 'NOTE' on a separate leaflet.

1.3 Soldering Hints :

Mount the component against the PCB surface and carefully solder the leads

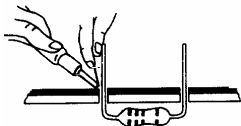

Make sure the solder joints are cone-shaped and shiny



Trim excess leads as close as possible to the solder joint

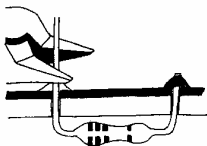

AXIAL COMPONENTS ARE TAPED IN THE CORRECT MOUNTING SEQUENCE !

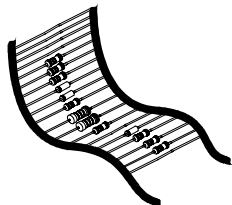

REMOVE THEM FROM THE TAPE
ONE AT A TIME !

5%

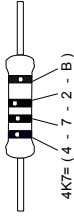

4K7= (4 - 7 - 2 - B)

1%

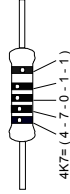

4K7= (4 - 7 - 0 - 0 - 1 - 1)

COLOR= 2...5



	I	P	E	SF	S	DK	N	D	GB	F	NL	
C	CODICE	CODIGO	CODIGO	VÄRI	FÄRG	FÄRVE-	FARGE-	FARB	COLOUR	CODIFI-	KLEURK-	
O	COLORE	DE CORES	DE COL-	KOODI	SCHEMA	KODE	KODE	KODE	CODE	CATION	ODE	
D			ORES							DES COL-	D	
E										LEURS	E	
0	Nero	Preto	Negro	Musta	Svart	Sort	Sort	Schwarz	Black	Noir	Zwart	0
1	Marrone	Castanho	Marrón	Ruskea	Brun	Brun	Brun	Braun	Brown	Brun	Bruin	1
2	Rosso	Encarnado	Rojo	Punainen	Röd	Röd	Röd	Rot	Red	Rouge	Rood	2
3	Aranciato	Laranja	Naranja	Oranssi	Orange	Orange	Orange	Orange	Orange	Orange	Oranje	3
4	Giallo	Amarelo	Amarillo	Keltainen	Gul	Gul	Gul	Gelb	Yellow	Jaune	Geel	4
5	Verde	Verde	Verde	Vihreä	Grön	Gron	Gronn	Grün	Green	Vert	Groen	5
6	Blu	Azul	Azul	Sininen	Blå	Blå	Blå	Blau	Blue	Bleu	Blauw	6
7	Viola	Violeta	Morado	Purppura	Lila	Violet	Violet	Violet	Purple	Violet	Paars	7
8	Grigio	Cinzeno	Gris	Harmaa	Grå	Grå	Grå	Grau	Grey	Gris	Grijs	8
9	Bianco	Branco	Blanco	Valkoinen	Vit	Hvidt	Hvidt	Weiss	White	Blanc	Wit	9
A	Argento	Prateado	Plata	Hopea	Silver	Sølv	Sølv	Silber	Silver	Argent	Zilver	A
B	Oro	Dourado	Oro	Kulta	Guld	Guld	Guldt	Gold	Gold	Or	Goud	B

1. Jumper

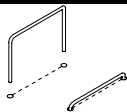

J (2x)

2. Resistors

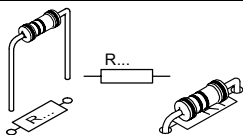

- R1 : 10K (1-0-3-B)
- R2 : 10K (1-0-3-B)
- R3 : 1K (1-0-2-B)
- R4 : 1K (1-0-2-B)
- R5 : 10K (1-0-3-B)
- R6 : 100K (1-0-4-B)
- R7 : 100K (1-0-4-B)
- R10 : 10K (1-0-3-B)
- R11 : 10K (1-0-3-B)
- R12 : 100K (1-0-4-B)
- R13 : 100K (1-0-4-B)
- R14 : 1K5 (1-5-2-B)
- R15 : 1K5 (1-5-2-B)
- R16 : 1K5 (1-5-2-B)
- R17 : 1K5 (1-5-2-B)
- R18 : 1K (1-0-2-B)
- R19 : 1K (1-0-2-B)
- R20 : 10K (1-0-3-B)
- R21 : 10K (1-0-3-B)
- R22 : 10K (1-0-3-B)
- R23 : 10K (1-0-3-B)

- R24 : 10K (1-0-3-B)
- R25 : 10K (1-0-3-B)
- R26 : 10K (1-0-3-B)
- R27 : 1K (1-0-2-B)
- R28 : 47K (4-7-3-B)
- R29 : 47K (4-7-3-B)
- R30 : 47K (4-7-3-B)
- R31 : 47K (4-7-3-B)
- R32 : 47K (4-7-3-B)
- R33 : 47K (4-7-3-B)
- R34 : 47K (4-7-3-B)
- R35 : 1K5 (1-5-2-B)
- R36 : 1K (1-0-2-B)
- R37 : 1K (1-0-2-B)
- R38 : 1K (1-0-2-B)
- R39 : 1K (1-0-2-B)
- R40 : 1K (1-0-2-B)
- R41 : 1K (1-0-2-B)
- R42 : 1K (1-0-2-B)
- R43 : 1K (1-0-2-B)



Remark:

R8 & R9 are not mounted at this time. 4 Resistors should be left over!

3. Diodes. Check the polarity!

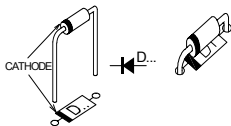

- D1 : 1N4148
- D2 : 1N4148

4. Capacitors

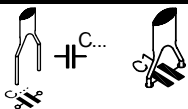

- C1 : 100nF (104, 0.1, u1)
- C2 : 100nF (104, 0.1, u1)
- C3 : 100nF (104, 0.1, u1)
- C4 : 33pF (33)
- C5 : 33pF (33)
- C7 : 100nF (104, 0.1, u1)

5. IC sockets. Watch the position of the notch!

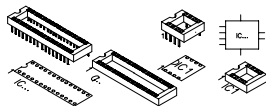

- IC1 : 14P
- IC2 : 18P
- IC3 : 28P
- IC4 : 18P

6. Push buttons

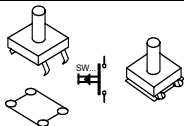

- SW1
 - SW2
 - SW3
 - SW4
 - SW5
- } KRS0610

7. Potentiometer

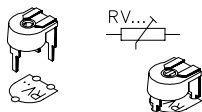

- RV1 : 100K
- RV2 : 100K

8. Capacitors

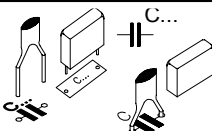

- C6: 220nF/ 50V

9. LED's. Watch the polarity!

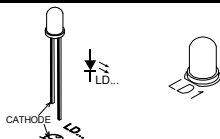

- LD1
 - LD2
 - LD3
 - LD4
 - LD5
 - LD6
 - LD7
 - LD8
 - LD9
 - LD10
 - LD11
- } 3mm RED

10. Transistors

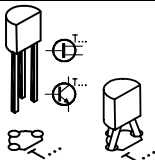

- T1 : BC337
- T2 : BC337

11. USB connector

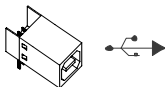

- SK7 : USBB90

12. Electrolytic capacitors. Check the polarity !

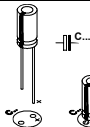

- C8 : 4,7 μ F/50V

13. Quartz crystal

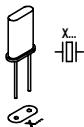

- X1 : 6MHz

14. Pin header

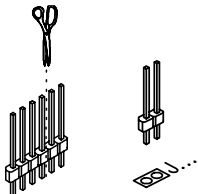

- SK2 : 2P
- SK3 : 2P
- SK5 : 2P
- SK6 : 2P

15. Screw connectors

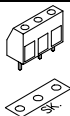

- SK1 : 3P

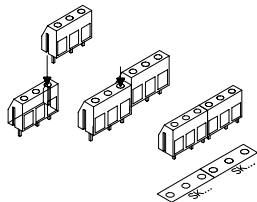

- SK4 : 2 x 3P

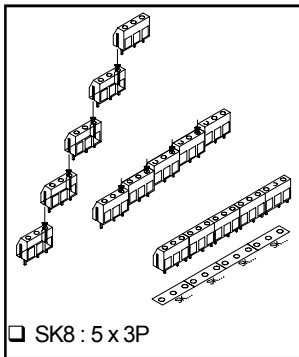

16. IC's. Watch the position of the notch!

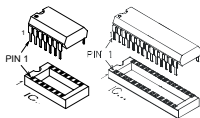

- IC1 : TLV274IN
- IC2 : ULN2803
- IC3 : VK8055
- Programmed PIC16C745-IP !
- IC4 : ULN2803

17. GAIN FACTOR

When the input voltage is too low you can amplify it x4 / x15.

A gain of x4 requires a resistance of 3K3 for R8 (input signal 1) and for R9 (input signal 2). A x15 gain requires a resistance of 820ohm.

If you want a different gain factor you can calculate it quite easily using the following formula :

$$\text{Gain A1} = 1 + (R10/R8)$$

$$\text{Gain A2} = 1 + (R11/R9)$$

18. Rubber feet

Mount the rubber feet on the solder side of the PCB, see fig 1.0.

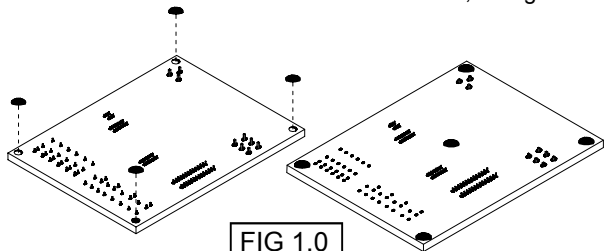
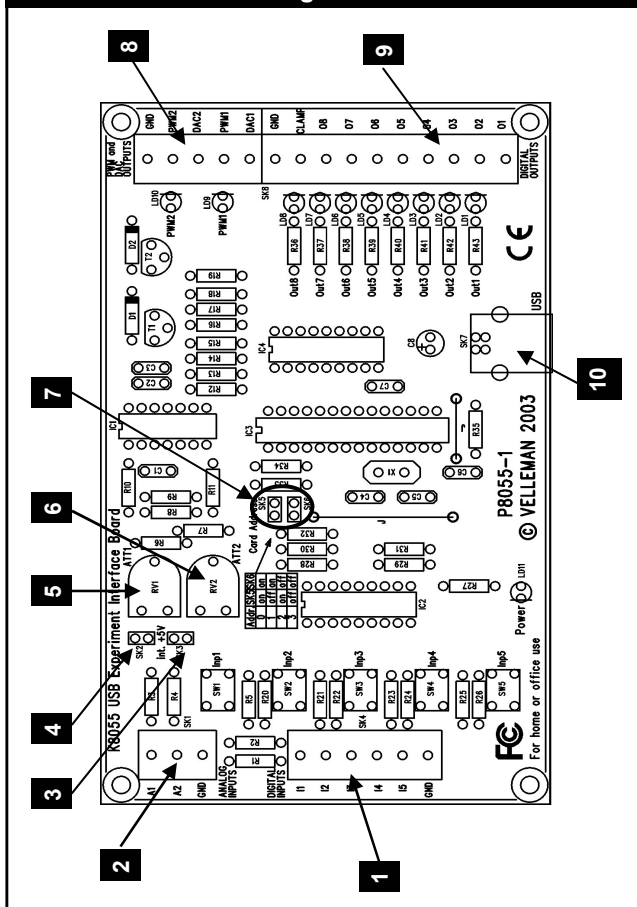

FIG 1.0

19. Connections / settings



- 1 5 digital inputs (e.g. push button, switch, relay contact, ...).
Input is generally "high" (1), connection to GND makes the input "low" (0)
- 2 Analogue inputs (e.g. temperature sensor, potentiometer, ...)
- 3 If the jumper is mounted, then you can use the internal voltage and adjust it using RV2/RV1. If the jumper is not mounted you must use the external voltage A2/A1.
- 4
- 5 Setting of the internal voltage for input A1.
- 6 Setting of the internal voltage for input A2.
- 7 Address selection, open = 1, closed = 0
- 8 Analogue outputs.
- 9 Digital outputs
- 10 USB connection to computer

Select the correct address in the test program

DIGITAL OUTPUTS

8 open collector contacts, to be connected with suitable inputs.

ANALOGUE OUTPUTS

- 2 analogue outputs with an output voltage between 0 and +5V (impedance 1K5).
- 2 PWM outputs with a pulse width modulation between 0 and 100%.



REMARK: the analogue outputs and PWM outputs are always activated /deactivated together.

20. Demo-software installation

- Start "Setup.exe", this software is located at the folder c:\.... From the Velleman Software CD. If the necessary software is not included or if you want to check for updates, you can always download it for free from our Velleman Website www.velleman.be
- An installation wizard will guide you through the installation procedure.
- By default the software is installed in the folder : 'C:\Program Files\Velleman\K8055'

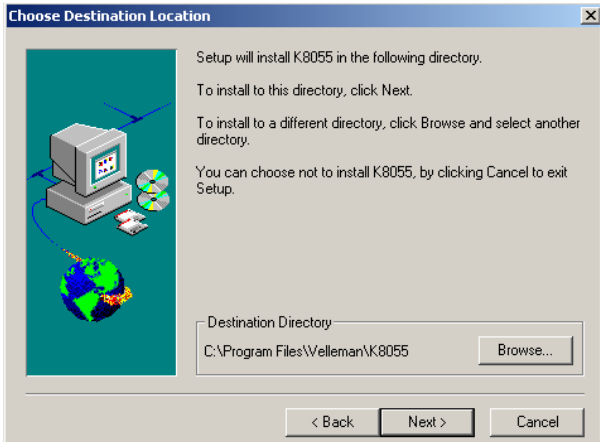

Fig 2.0

21 Test procedure

The included demo software makes it easy to experiment.

Start by selecting the address : tick off SK5 and/or SK6 (see address selection).

SK5	SK6	ADDRESS
ON	ON	0
OFF	ON	1
ON	OFF	2
OFF	OFF	3

ATTENTION : Execute these settings before connecting the kit with the computer or before booting the computer.

- × Connect the USB cable.
- × LED LD3 'Power' lights up if the connection has been executed properly.
- × After startup LD4 (output 4) will flash momentarily to indicate that the circuit works as it should.
- × Start the program 'K8055_Demo.exe'.

Next press the 'connect' button to connect the K8055 with the computer.

The message "Card x connected" is displayed if the connection is successful, see fig 3.0.

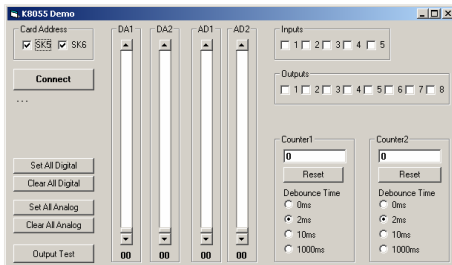

FIG 3.0

You can now simulate the inputs via push buttons Inp1 through Inp5. The matching check box remains ticked off as long as you keep one of the push buttons pressed down.

Always tick off the check box for the matching output if you wish to test a digital output.

You can also conduct this procedure automatically : press the 'output test' button or activate all outputs with the 'Set all digital' button. Press the 'output test' button to test all digital outputs automatically.

Test the analogue outputs with the 'set all analog' button and modify the output voltage with DA1 & DA2

Counter 1 & 2 are hardware integrated 16-bit converters, they are triggered by INP1 & INP2.

You can test the counter with push buttons Inp1 and Inp2 : the counter adds 1 every time one of these two buttons is pressed. The debouncing control allows you to determine the reaction time of the counter (0ms - 2ms - 10ms - 1000ms).

You can use the internal analogue voltage to simulate the analogue input via potentiometers ATT1 (RV1) & ATT2 (RV2).

The scroll bars AD1 & AD2 change on the screen whenever you adjust the position of the potentiometers. The "digital" value (0 to 255) of this internal analogue voltage can be read directly under the scroll bars.

22. Schematic diagram.

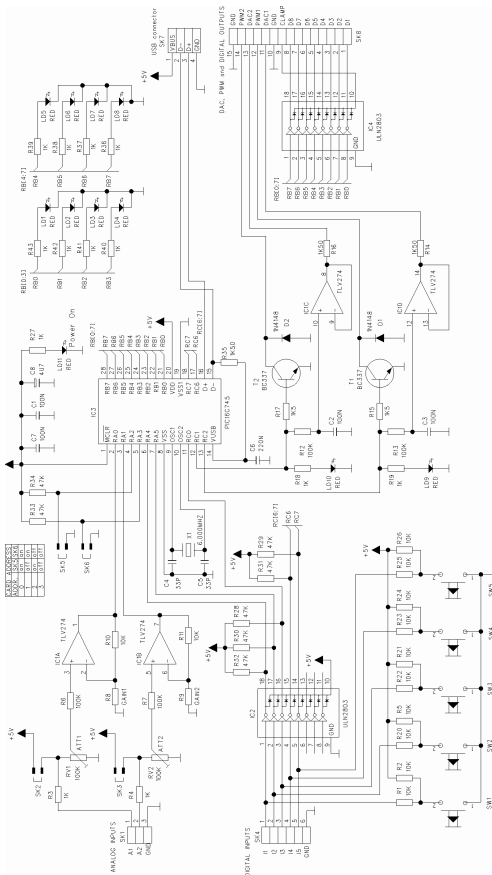

23. PCB layout.

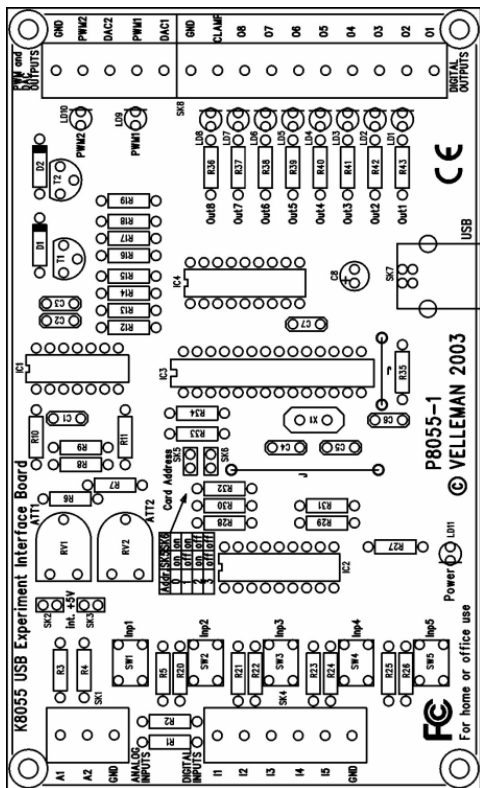

Modifications and typographical errors reserved
 © Velleman Components nv.
 H8055IP - 2003 - ED1