

Total solder points: 49

Difficulty level: *beginner* 1  2  3  4  5  *advanced*

## UNIVERSAL START/STOP TIMER

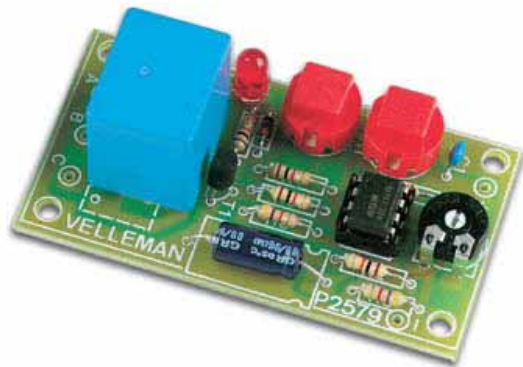

# *K2579*

*Small size timer provides up to 60 minutes delay.*



The K2579 is a basic timer with relay output for time intervals of up to 15 minutes.

Set the desired delay with the trimmer.

The maximum delay can easily be lengthened and the timer can be stopped and restarted at any time.

## Features

- ☑ Start / stop push buttons included.
- ☑ LED status indicator.
- ☑ Timing adjustable from a few seconds to 15 minutes, extendable to 60 minutes.
- ☑ Relay output with switchover contact.

## Specifications :

- Power supply : 12VDC regulated.
- Typical idle current : 20mA.
- Typical active current : 55mA.
- Relay output : 2A/240V max.
- Dimensions : 38x69mm / 1.5"x2.7".

### 1. Assembly (Skipping this can lead to troubles !)

Ok, so we have your attention. These hints will help you to make this project successful. Read them carefully.

#### 1.1 Make sure you have the right tools:

- A good quality soldering iron (25-40W) with a small tip.
- Wipe it often on a wet sponge or cloth, to keep it clean; then apply solder to the tip, to give it a wet look. This is called 'thinning' and will protect the tip, and enables you to make good connections. When solder rolls off the tip, it needs cleaning.
- Thin rosin-core solder. Do not use any flux or grease.
- A diagonal cutter to trim excess wires. To avoid injury when cutting excess leads, hold the lead so they cannot fly towards the eyes.
- Needle nose pliers, for bending leads, or to hold components in place.
- Small blade and Phillips screwdrivers. A basic range is fine.

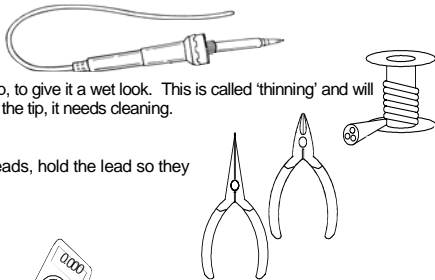

**For some projects, a basic multi-meter is required, or might be handy**

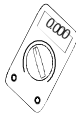

#### 1.2 Assembly Hints :

- ⇒ Make sure the skill level matches your experience, to avoid disappointments.
  - ⇒ Follow the instructions carefully. Read and understand the entire step before you perform each operation.
  - ⇒ Perform the assembly in the correct order as stated in this manual
  - ⇒ Position all parts on the PCB (Printed Circuit Board) as shown on the drawings.
  - ⇒ Values on the circuit diagram are subject to changes.
  - ⇒ Values in this assembly guide are correct\*
  - ⇒ Use the check-boxes to mark your progress.
  - ⇒ Please read the included information on safety and customer service
- \* Typographical inaccuracies excluded. Always look for possible last minute manual updates, indicated as 'NOTE' on a separate leaflet.

### 1.3 Soldering Hints :

1- Mount the component against the PCB surface and carefully solder the leads

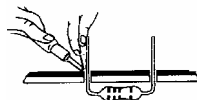

2- Make sure the solder joints are cone-shaped and shiny

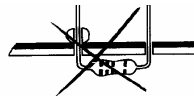
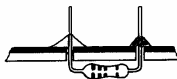

3- Trim excess leads as close as possible to the solder joint



**AXIAL COMPONENTS ARE TAPED IN THE CORRECT MOUNTING SEQUENCE !**

**REMOVE THEM FROM THE TAPE ONE AT A TIME !**

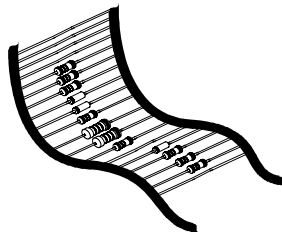

 You will find the colour code for the resistances and the LEDs in the HALG (general manual) and on our website: <http://www.velleman.be/common/service.aspx>

**1. Diode. Watch the polarity !**

D1 : 1N4148

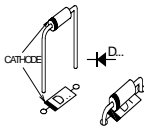
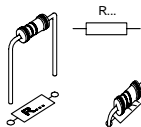
**2. Resistor**

- R1 : 1K (1 - 0 - 2 - B)
- R2 : 10K (1 - 0 - 3 - B)
- R3 : 4K7 (4 - 7 - 2 - B)
- R4 : 1K (1 - 0 - 2 - B)
- R5 : 10K (1 - 0 - 3 - B)
- R6 : 4K7 (4 - 7 - 2 - B)
- R7 : 1K (1 - 0 - 2 - B)

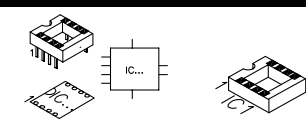
**3. IC socket. Check the position of the notch!**

IC : 8p.

**4. Capacitor**

C1 : 100nF

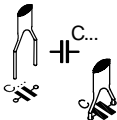
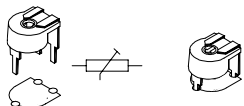
**5. Trim potentiometer**

RV1 : 2M2

**6. Transistor**

T1 : BC547B

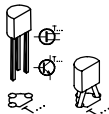
**7. Electrolytic Capacitor. Watch the polarity !**

C2 : 100µF

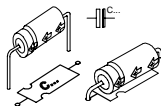
**8. LED. Check the polarity!**

LD1 : 5mm RED

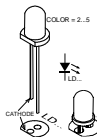

## 9. Push buttons

- SW1: START
- SW2: STOP

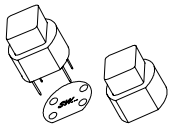

## 10. Relay

- RY : VR15M121C

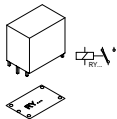

## 11. IC. Check the position of the notch!

- IC : NE555

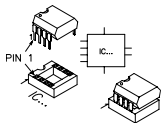

## 12. Connection example

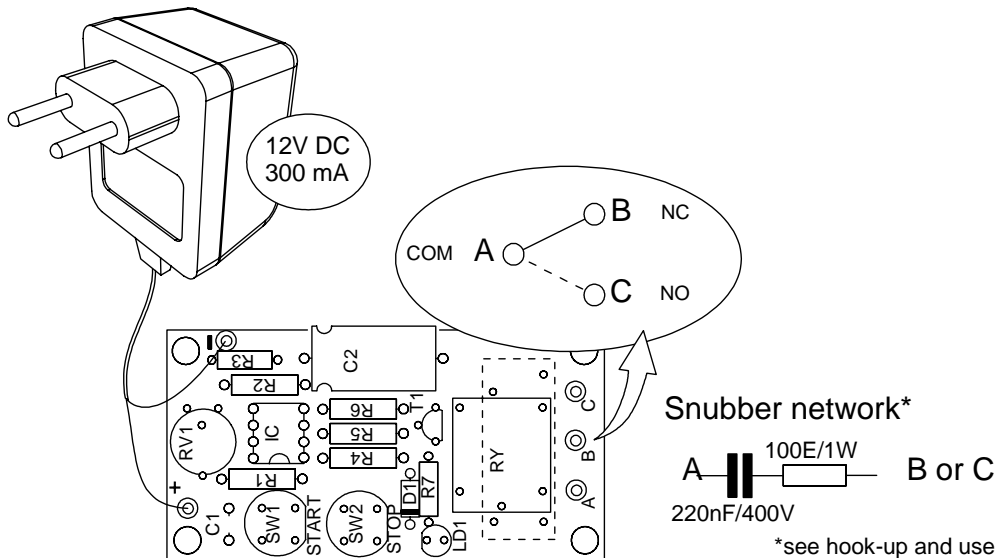



### 13. Hook-up and use

- Connect the unit with a 12VDC regulated power supply as shown in the example.
- Turn the trimmer all the way counterclockwise.
- Push the START button. The relay will be activated momentarily.
- The position of the trimmer determines the ON-time. Turn it clockwise to increase the ON-time.
- Increase the value of C2 for an even longer activation duration.
- The unit can be stopped at any time by pressing the STOP button.
- The START and STOP buttons can be mounted in a remote location. Make sure to use screened cable, avoid outside interference and keep the distance between the switches and the PCB as short as possible.
- The timer is equipped with a relay output that is galvanically separated from the rest of the circuit for extra safety. The connection example lists the function of the pins of the relay contacts.
- If the relay is used to switch important inductive loads, such as electric motors or transformers, it may be necessary to install a snubber network across the relay contacts to avoid excessive contact wear.

 **Ensure that the power supply of the circuit is sufficiently HF decoupled. Noise impulses entering through the power supply may start and stop the circuit unnecessarily.**

## 14. PCB layout.

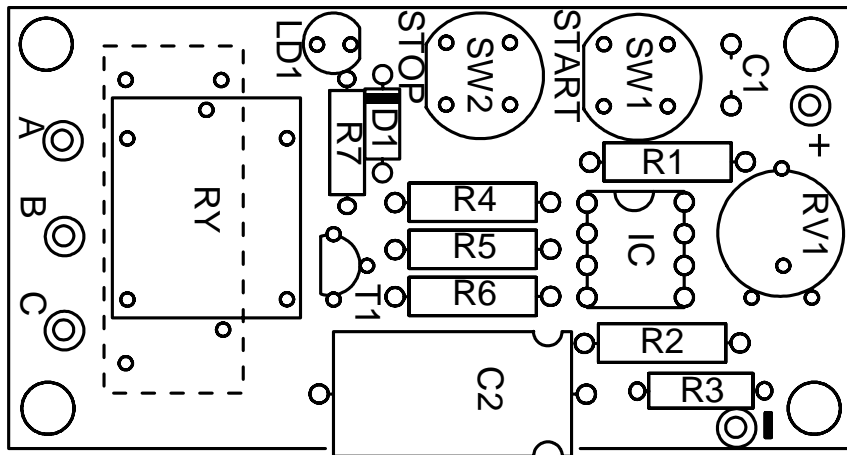

15. Diagram

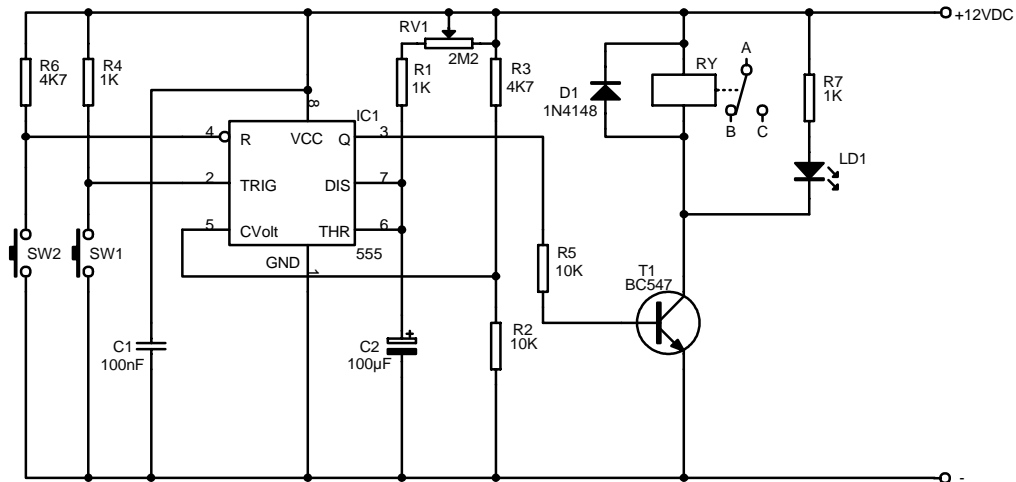



Modifications and typographical errors reserved  
© Velleman Components nv.  
H2579P - 2004 - ED1

