

FEATURES

• **Compact (half-size).**

The base area is approximately half the size of conventional (JS-M) relays. The controller unit can be made more compact. Base area has been reduced by one half

• **Standard terminal pitch employed**

The terminal array used is identical to that used in small automotive relays.

• **Plastic sealed type.**

Plastically sealed for automatic cleaning.

• **Line-up of 1 Form A and 1 Form C.**

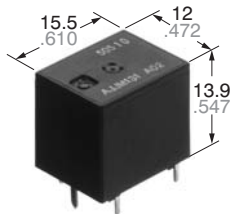

mm inch

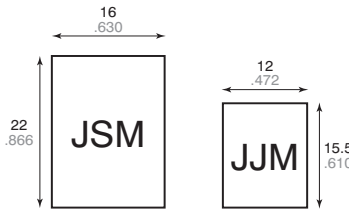

• **Perfect for automobile electrical systems.**

Over 2×10^5 openings possible with a 14 V DC motor load, an inrush current of 25 A, and steady state current of 5 A. (N.O. side)

TYPICAL APPLICATIONS

- Power windows
- Auto door lock
- Electrically powered sun roof
- Electrically powered mirror
- Cornerring lamp, etc.

SPECIFICATIONS

Contact

Arrangement	1 Form A		1 Form C	
Contact material	AgSnO ₂ type			
Initial contact resistance (By voltage drop 6V DC 1A)	Max. 100 mΩ			
Rating (resistive load)	Nominal switching capacity	20 A 14 V DC	20 A 14 V DC (N.O.) 10 A 14 V DC (N.C.)	
	Min. switching capacity ^{#1}	1 A 12 V DC		
	Max. carrying current	35 A (12V, at 20°C 68°F for 2 minutes) 25 A (12V, at 20°C 68°F for 1 hour) 30 A (12V, at 85°C 185°F for 2 minutes) 20 A (12V, at 85°C 185°F for 1 hour)		
Expected life (min. operations)	Mechanical (at 120cpm)	10 ⁷		
	Electrical (at rated load)	Resistive	10 ⁵ *1	10 ⁵ (N.O.)*2 10 ⁵ (N.C.)*3
		Motor load	2×10 ⁵ *4 5×10 ⁴ *5	2×10 ⁵ (N.O.)*6 5×10 ⁴ (N.O.)*7 2×10 ⁵ (N.C.)*8

Coil

Nominal operating power	640 mW
-------------------------	--------

#1 This value can change due to the switching frequency, environmental conditions, and desired reliability level, therefore it is recommended to check this with the actual load.

Remarks

- *1 at 20 A 14 V DC, at 20 cpm, operating frequency: 1s ON, 9s OFF
- *2 at 20 A 14 V DC, operating frequency: 1s ON, 9s OFF
- *3 at 10 A 14 V DC, at 20 cpm, operating frequency: 1s ON, 9s OFF
- *4 at 5 A (steady), 25 A (inrush) 14 V DC
- *5 at 20 A 14 V DC (Motor lock), operating frequency: 0.5 s ON, 9.5 s OFF
- *6 at 5A (steady), 25 A (inrush) 14 V DC

Characteristics

Max. operating speed (at rated load)	6 cpm	
Initial insulation resistance ^{*9}	Min. 100 MΩ (at 500 V DC)	
Initial breakdown voltage ^{*10}	Between open contacts	500 Vrms for 1min.
	Between contact and coil	500 Vrms for 1min.
Operate time ^{*11} (at nominal voltage)	Max. 10 ms (at 20°C 68°F)	
Release time (without diode) ^{*11} (at nominal voltage) (Initial)	Max. 10 ms (at 20°C 68°F)	
Shock resistance	Functional ^{*12}	Min. 100 m/s ² {10 G}
	Destructive ^{*13}	Min. 1,000 m/s ² {100 G}
Vibration resistance	Functional ^{*14}	10 Hz to 100 Hz, Min. 44.1 m/s ² {4.5 G}
	Destructive ^{*15}	10 Hz to 500 Hz, Min. 44.1 m/s ² {4.5 G}
Conditions in case of operation, transport and storage ^{*16} (Not freezing and condensing at low temperature)	Ambient temp.	-40°C to +85°C -40°F to +185°F
	Humidity	5% R.H. to 85% R.H.
Mass	Approx. 5 g .176 oz	

- *7 at 20 A 14 V DC (Motor lock)
- *8 at peak 20 A 14 V DC (Braking current) operating frequency: 0.5 s ON, 9.5 s OFF
- *9 Measurement at same location as "Initial break down voltage" section.
- *10 Detection current: 10mA
- *11 Excluding contact bounce time.
- *12 Half-wave pulse of sine wave: 11 ms; detection time: 10 μs
- *13 Half-wave pulse of sine wave: 6 ms
- *14 Detection time: 10 μs
- *15 Time of vibration for each direction; X, Y, Z direction: 2 hours



*16 Refer to 6. Conditions for operation, transport and storage mentioned in [AMBIENT ENVIRONMENT \(p. 19, Relay Technical Information\)](#).

JJ-M

ORDERING INFORMATION

Ex. JJM

1a

12 V

Contact arrangement	Coil voltage(DC)
1a: 1 Form A 1: 1 Form C	12 V

(Note) Standard packing: Carton: 50 pcs.; Case: 1,000 pcs.

TYPES AND COIL DATA (at 20°C 68°F)

Contact arrangement	Part No.	Nominal voltage, V DC	Pick-up voltage, V DC (Initial)	Drop-out voltage, V DC (Initial)	Coil resistance Ω	Nominal operating current mA	Nominal operating power mW	Usable voltage range, V DC
1 Form A	JJM1a-12 V	12	Max. 7.2	Min. 1.0	225 \pm 10%	53.3 \pm 10%	640	10 to 16
1 Form C	JJM1-12 V	12	Max. 7.2	Min. 1.0	225 \pm 10%	53.3 \pm 10%	640	10 to 16

* Other pick-up voltage types are also available. Please contact us for details.

DIMENSIONS

mm inch

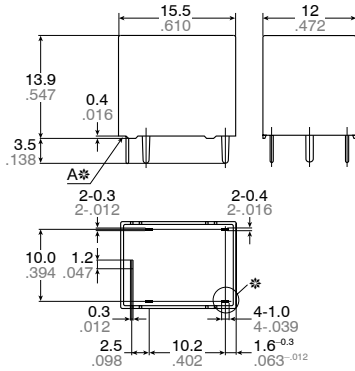

Note: *Marked terminal is only for 1Form C type

* Dimensions (thickness and width) of terminal specified in this catalog is measured before pre-soldering.
Intervals between terminals is measured at A surface level.

Schematic (Bottom view)

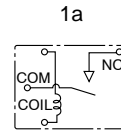

1c

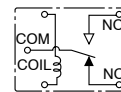

PC board pattern (Bottom view)

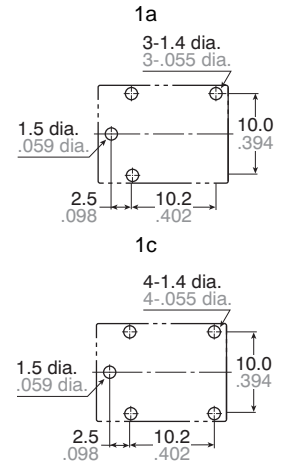

Tolerance: $\pm 0.1 \pm .004$

Dimension:	General tolerance
Max. 1mm .039 inch:	$\pm 0.1 \pm .004$
1 to 3mm .039 to .118 inch:	$\pm 0.2 \pm .008$
Min. 3mm .118 inch:	$\pm 0.3 \pm .012$

REFERENCE DATA

1. Coil temperature rise

Sample: JJM1-12V, 6pcs
Point measured: Inside the coil
Contact current: Now current through contact, 5A, 10A, 15A, 20A
Resistance method, ambient temperature 85°C 185°F

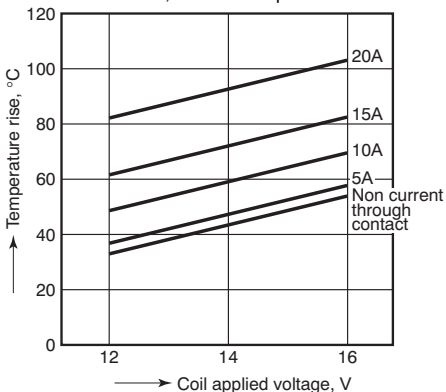

2. Max. switching capability (Resistive load)

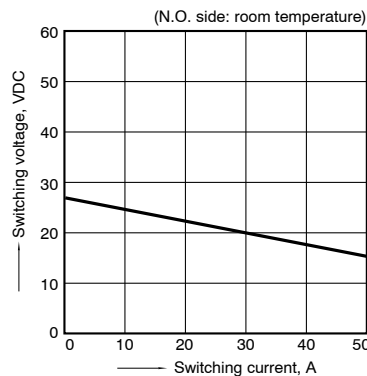

3. Ambient temperature and operating voltage range

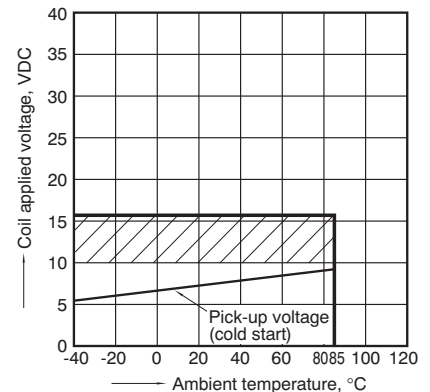

4. Distribution of pick-up and drop-out voltage
Sample: JJM1-12V, 100pcs

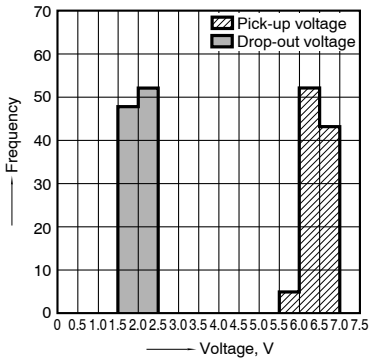

5. Distribution of operate time
Sample: JJM1-12V, 100pcs

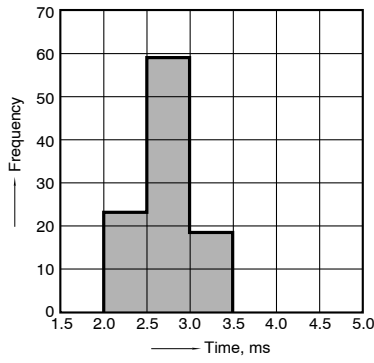

6. Distribution of release time
Sample: JJM1-12V, 100pcs
* With diode

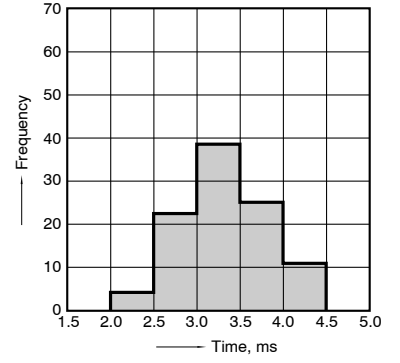

7-(1). Electrical life test (at rated load)

Sample: JJM1-12V
Quantity: n = 6 (NC = 3, NO = 3)
Load: Resistive load (NC side: 10A 14 V DC, NO side: 20 A 14 V DC); Operating frequency: ON 1s, OFF 9s
Ambient temperature: Room temperature

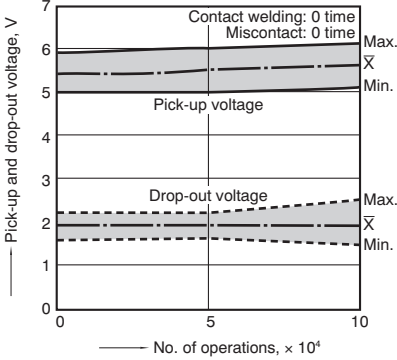

7-(2). Electrical life test (Motor free)

Sample: JJM1-12V, 6pcs.
Load: 5A, Inrush 25A, Brake current 18A 14V DC, Power window motor load (Free condition).
Operating frequency: (ON : OFF = 0.5s : 9.5s)
Ambient temperature: Room temperature

Circuit :

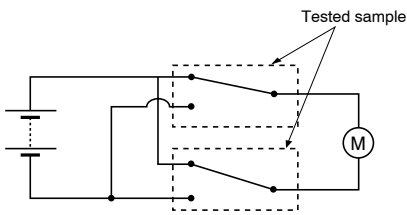

Change of pick-up and drop-out voltage

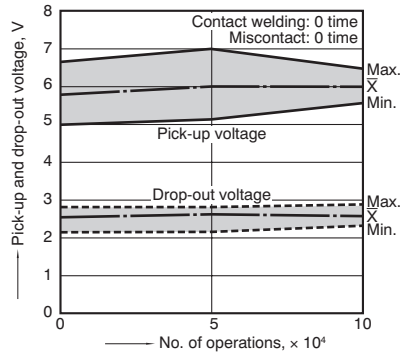

Change of contact resistance

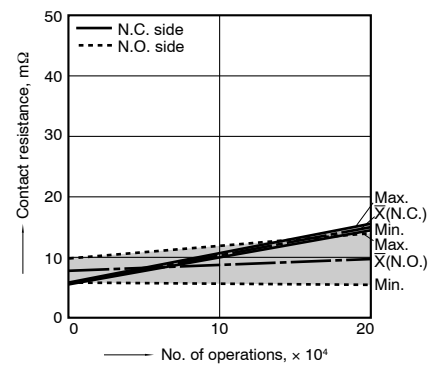

7-(3). Electrical life test (Motor lock)

Sample: JJM1-12V, 6pcs.
Load: 20A, 14VDC, Power window motor actual load (lock condition).
Operating frequency: (ON : OFF = 1s : 5s)
Ambient temperature: Room temperature

Circuit :

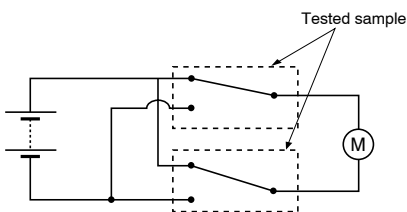

Change of pick-up and drop-out voltage

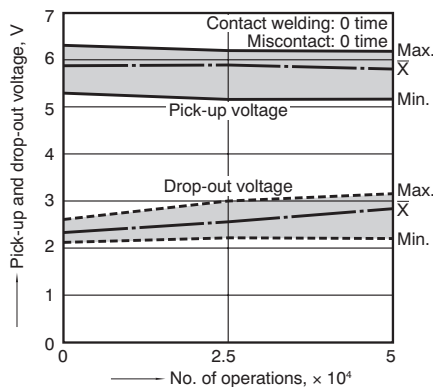

Change of contact resistance

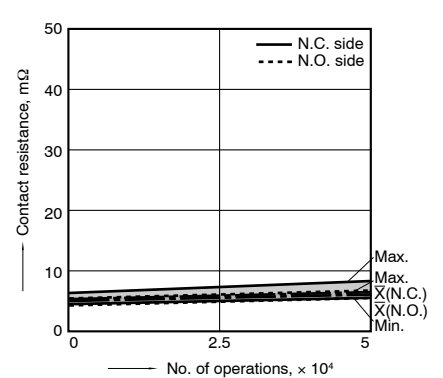

JJ-M

7-(4). Electrical life test (Lamp load)

Sample: JJM1-12V, 6pcs.

Load: 27W+21W, min. 4A (steady), Lamp actual load

Operating frequency: ON 2s, OFF 13s

Ambient temperature: Room temperature

Circuit :

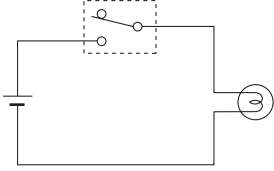

Inrush current: 42A, Steady current: 4.4A

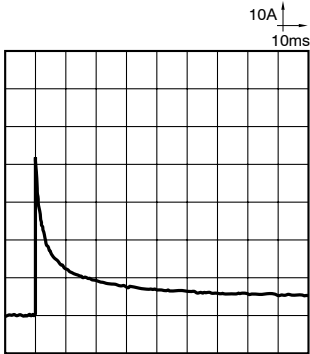

Change of pick-up and drop-out voltage

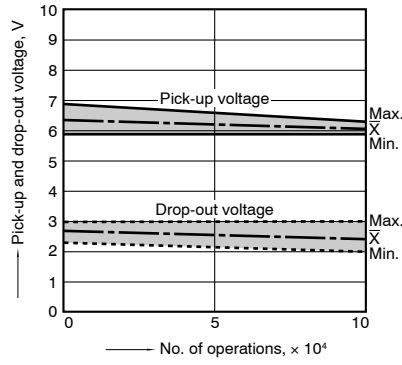

Change of contact resistance

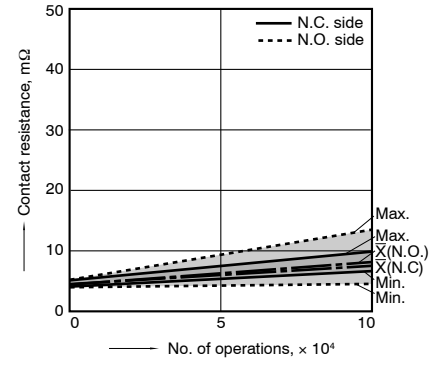

For Cautions for Use, see [Relay Technical Information](#).