

FBR 51, 52 SERIES

COMPACT POWER RELAY

FOR AUTOMOTIVE APPLICATIONS

Fujitsu's new compact relays offer a tremendous weight and space savings, providing an increased current handling capacity.

FEATURES

- Compact, Lightweight structure (42% the volume as compared with FBR160 relay)
- High current contact capacity (carrying current: 35A/2min, 25A/1Hr)
- High resistance to vibration and shock
- Improved Heat Resistance and Extended Operating Range
- Two types of contact gap (FBR51: 0.3 mm, FBR52: 0.6 mm)

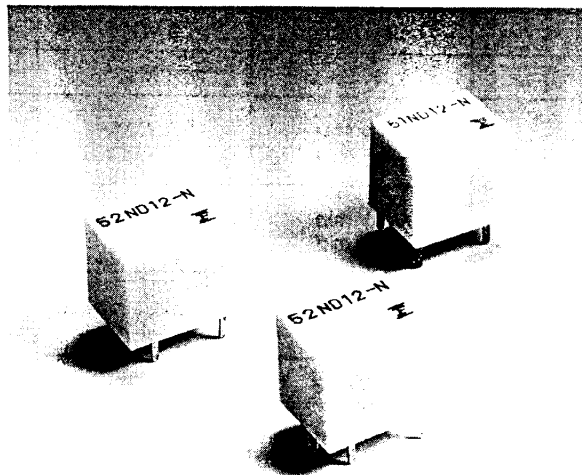

FBR 51, 52 SERIES

SPECIFICATIONS

Item	Specification
Contact Arrangement	1 form C
Contact Material	Silver-Tin oxide indium (-W type) Silver copper nickel (-N type)
Contact Voltage Drop (Contact Resistance)	100 mV Max. at 12 VDC-2 A
Vibration	No Contact Opening, No Damage: 10 G, 10 to 55Hz 1.5 mm double amplitude
Shock	No Contact Opening : 10 G Min. No Damage : 100 G Min.
Operate Time	10 ms Max. (excluding bounce time)
Release Time	5 ms Max. (excluding bounce time)
Operating Temperature Range	-40°C to +85°C
Storage Temperature Range	-40°C to +100°C
Mechanical Life	10 x 10 ⁶ Operations Minimum @ 5 Hz
Weight	6.0 Grams (approx.)

CONTACT CAPACITIES

Item	Specification
Contact Rating	14 VDC-20 A (LOCKED MOTOR LOAD) 14 VDC-INRUSH 20 A, BREAK 4 A (MOTOR FREE LOAD)
Maximum Carrying Current	35 A/2 min, 25A/1Hr (@ 25°C, 100% Rated Coil Voltage)
Maximum Inrush Current (Reference)	-W type : 60 A -N type : 40 A
Maximum Break Current	35 A at 16 VDC
Minimum Applicable Load (Reference)	-W type : 6 V, 1 A -N type : 6 V, 2 A

COIL RATINGS

Item		Specification			
FBR51	Rated Coil Voltage	6 VDC	9 VDC	10 VDC	12 VDC
	Coil Resistance (20 °C)	60 Ω	135 Ω	180 Ω	240 Ω
	Pick-Up Voltage (20 °C) (85 °C)	3.6 V max 4.5 V max	5.4 V max 6.8 V max	6.3 V max 7.9 V max	7.3 V max 9.2 V max
	Drop-Out Voltage (20 °C) (85 °C)	0.5 V min 0.6 V min	0.7 V min 0.8 V min	0.8 V min 0.9 V min	1.0 V min 1.2 V min
	Thermal Resistance	86°C/W			
FBR52	Rated Coil Voltage	6 VDC	9 VDC	10 VDC	12 VDC
	Coil Resistance (20 °C)	45 Ω	100 Ω	135 Ω	180 Ω
	Pick-Up Voltage (20 °C) (85 °C)	3.6 V max 4.5 V max	5.4 V max 6.8 V max	6.3 V max 7.9 V max	7.3 V max 9.2 V max
	Drop-Out Voltage (20 °C) (85 °C)	0.5 V min 0.6 V min	0.7 V min 0.8 V min	0.8 V min 0.9 V min	1.0 V min 1.2 V min
	Thermal Resistance	78°C/W			

ORDERING INFORMATION

[Example] $\frac{\text{FBR51}}{\text{(a)}} \frac{\text{N}}{\text{(b)}} \frac{\text{D12}}{\text{(c)}} - \frac{\text{W}}{\text{(d)}} \frac{\square}{\text{(e)}}$

(a)	Series Name	FBR51 : Standard Type (Contact Gap 0.3 mm) FBR52 : Wider Contact Gap Type (Contact Gap 0.6 mm)
(b)	Structure	N : For Automated Soldering + Immersion Cleaning (sealed case)
(c)	Rated Coil Voltage	ND06 : 6 VDC ND09 : 9 VDC ND10 : 10 VDC ND12 : 12 VDC
(d)	Contact Material	-W : Silver-Tin oxide indium -N : Silver copper nickel
(e)	Custom Designation	To be assigned custom specification

PART NUMBER LIST

Series Name	Rated Coil Voltage (VDC)	Contact Material	
		W-Type	N-Type
FBR51 Series (Contact Gap 0.3 mm)	6	FBR51ND06-W	FBR51ND06-N
	9	FBR51ND09-W	FBR51ND09-N
	10	FBR51ND10-W	FBR51ND10-N
	12	FBR51ND12-W	FBR51ND12-N
FBR52 Series (Contact Gap 0.6 mm)	6	FBR52ND06-W	FBR52ND06-N
	9	FBR52ND09-W	FBR52ND09-N
	10	FBR52ND10-W	FBR52ND10-N
	12	FBR52ND12-W	FBR52ND12-N

DIMENSIONS

• Dimensions

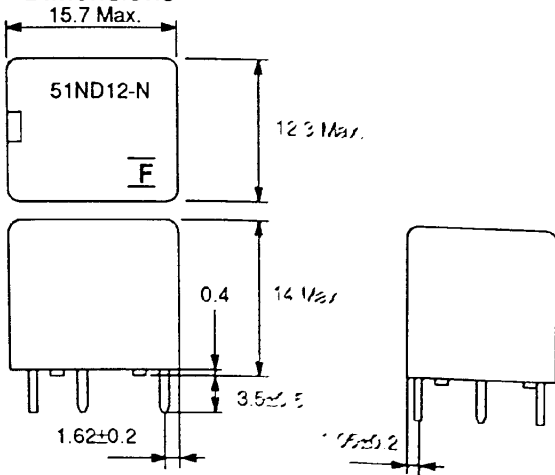

• Tube carrier

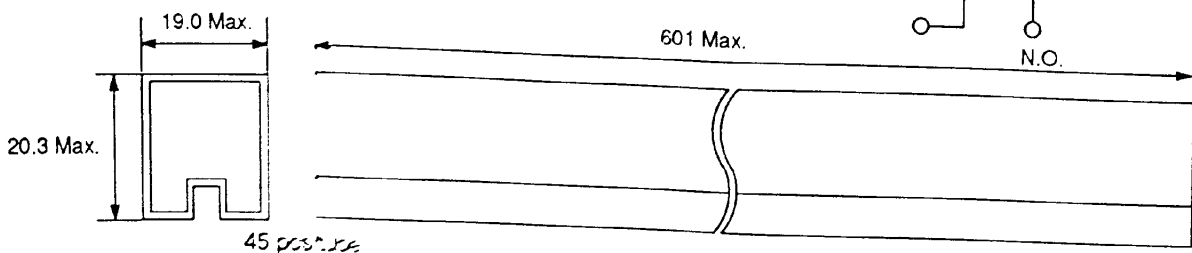

• PC board mounting hole layout

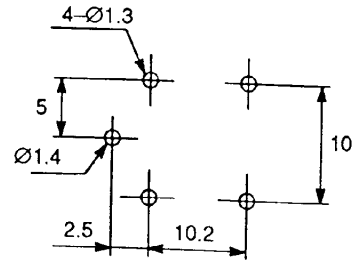

• Schematics (Bottom view)

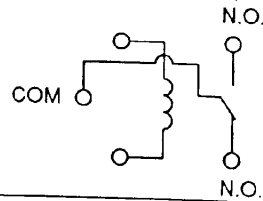

Unit : mm

FBR 51, 52 SERIES

PRINCIPAL APPLICATIONS

Application	Normal Load Current (12VDC System)	Description	Recommendable P / N (Example)	
			For 16 V or less motor load voltage	For instantaneous 20 V or more load voltage
Power Windows	20 to 25A (switching at motor locking)	Forward and Reverse Motor Control	FBR51N <input type="checkbox"/> - W	FBR52N <input type="checkbox"/> - W
Automatic Door Lock	18 to 25A (switching at motor locking)	Forward and Reverse Motor Control	FBR51N <input type="checkbox"/> - W	FBR52N <input type="checkbox"/> - W
Intermittent Wipers	15 to 30A Break 2 to 8A (motor-free)	Forward Only	FBR51N <input type="checkbox"/> - N	FBR52N <input type="checkbox"/> - N
Tilt-Lock Wheel	20A Break 5A (some with motor locking)	Forward and Reverse Motor Control	FBR51N <input type="checkbox"/> - W	FBR52N <input type="checkbox"/> - W
Sunroof	20 to 30A (switching at motor locking)	Forward and Reverse Motor Control	FBR51N <input type="checkbox"/> - W	FBR52N <input type="checkbox"/> - W
Adjustable Door Mirror	3 to 5A (switching at motor locking)	Forward and Reverse Motor Control	FBR51N <input type="checkbox"/> - W	
Automatic Antenna	8 to 12A (INRUSH) Break 2A Max. (motor-free)	Forward and Reverse Motor Control	FBR51N <input type="checkbox"/> - W	
Auto-Cruise	2 to 3A	Power Shutoff and Solenoid	FBR51N <input type="checkbox"/> - W	
Other	Car Audio System, etc.			

- For the load condition where higher voltage would be encountered during contact break, FBR52 series with wider contact gap is recommended.
- -N contact type is recommended for applications which require long durability and -W contact type is for high inrush current load applications.

DATA

(1) MAXIMUM BREAK CAPACITY

(2) LIFE

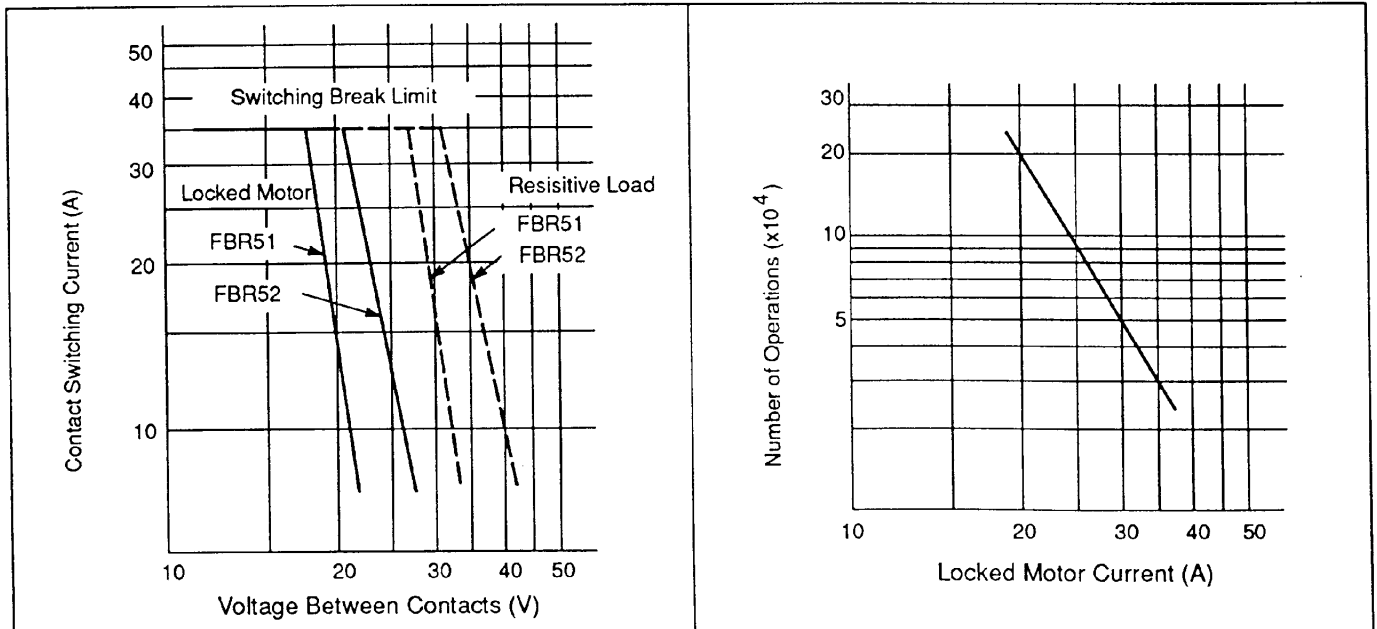

(3) LIFE TEST (EXAMPLE)

• Test Item

14 VDC-20A
Motor Lock
200,000 ops, MIN.

(FBR52□-W type)

• Test Circuit

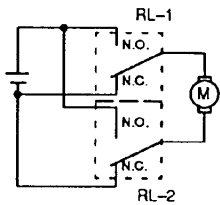

• Current Wave Form

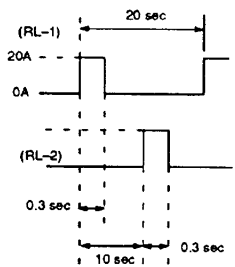

• Shift of Pick-up and Drop-out Voltage

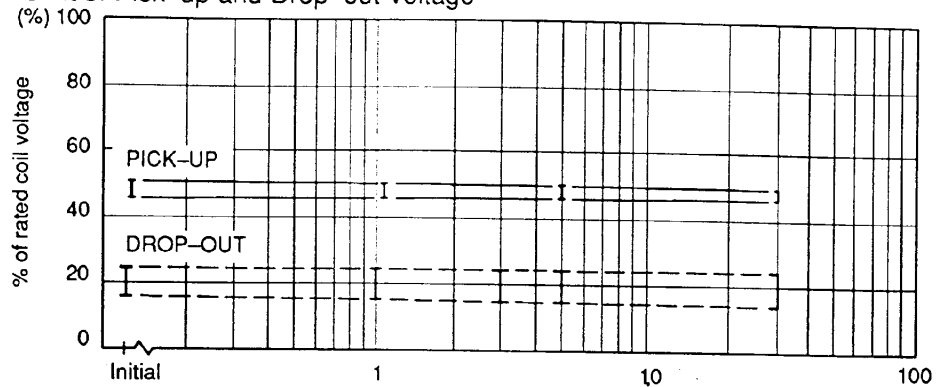

• Shift of Contact Resistance

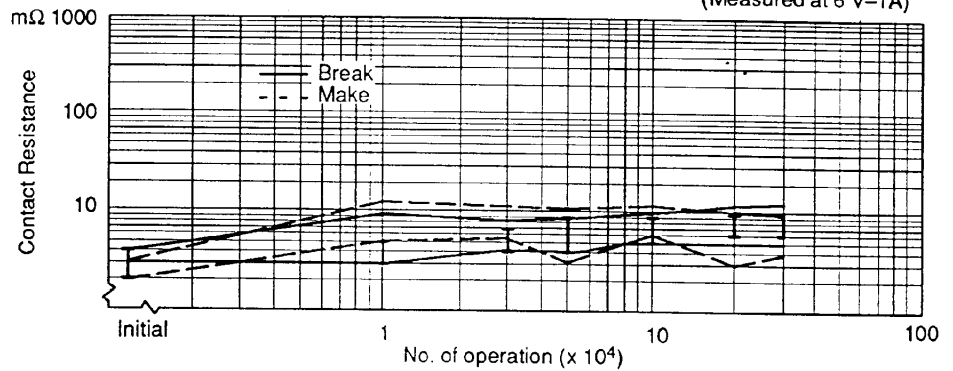

• Test Item

14 VDC-20A INRUSH
Motor Free
400,000 ops, MIN.

(FBR51□-N type)

• Test Circuit

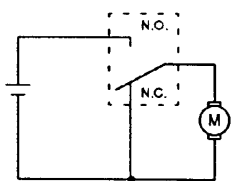

• Current Wave Form

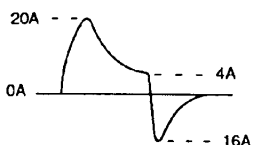

• Shift of Pick-up and Drop-out Voltage

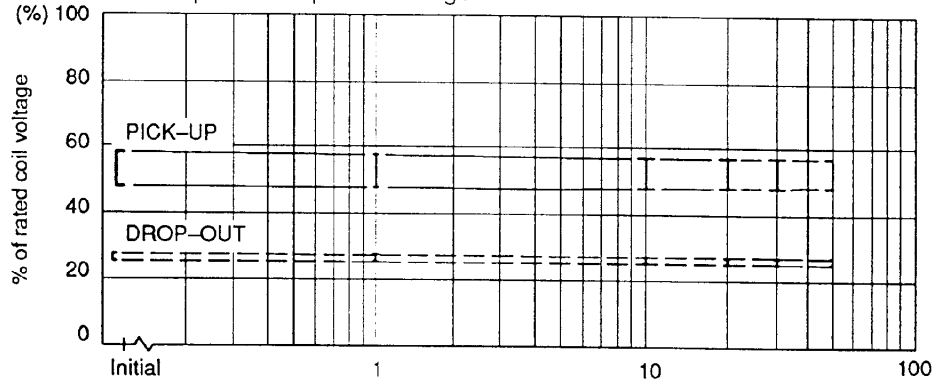

• Shift of Contact Resistance

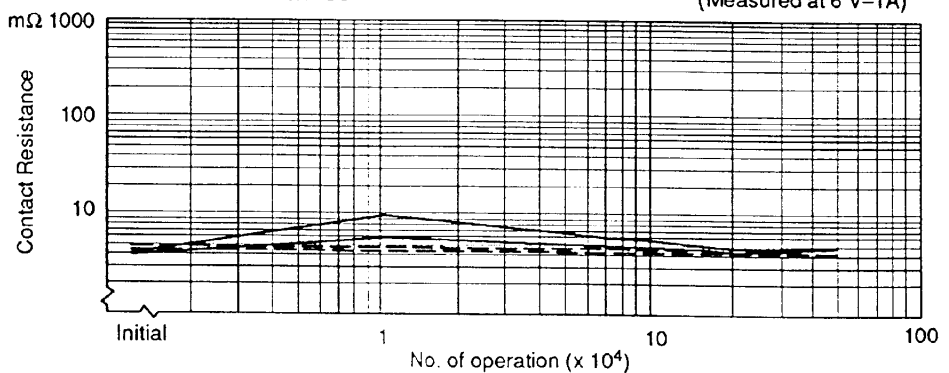

FBR 51, 52 SERIES

(4) COIL TEMPERATURE RISE

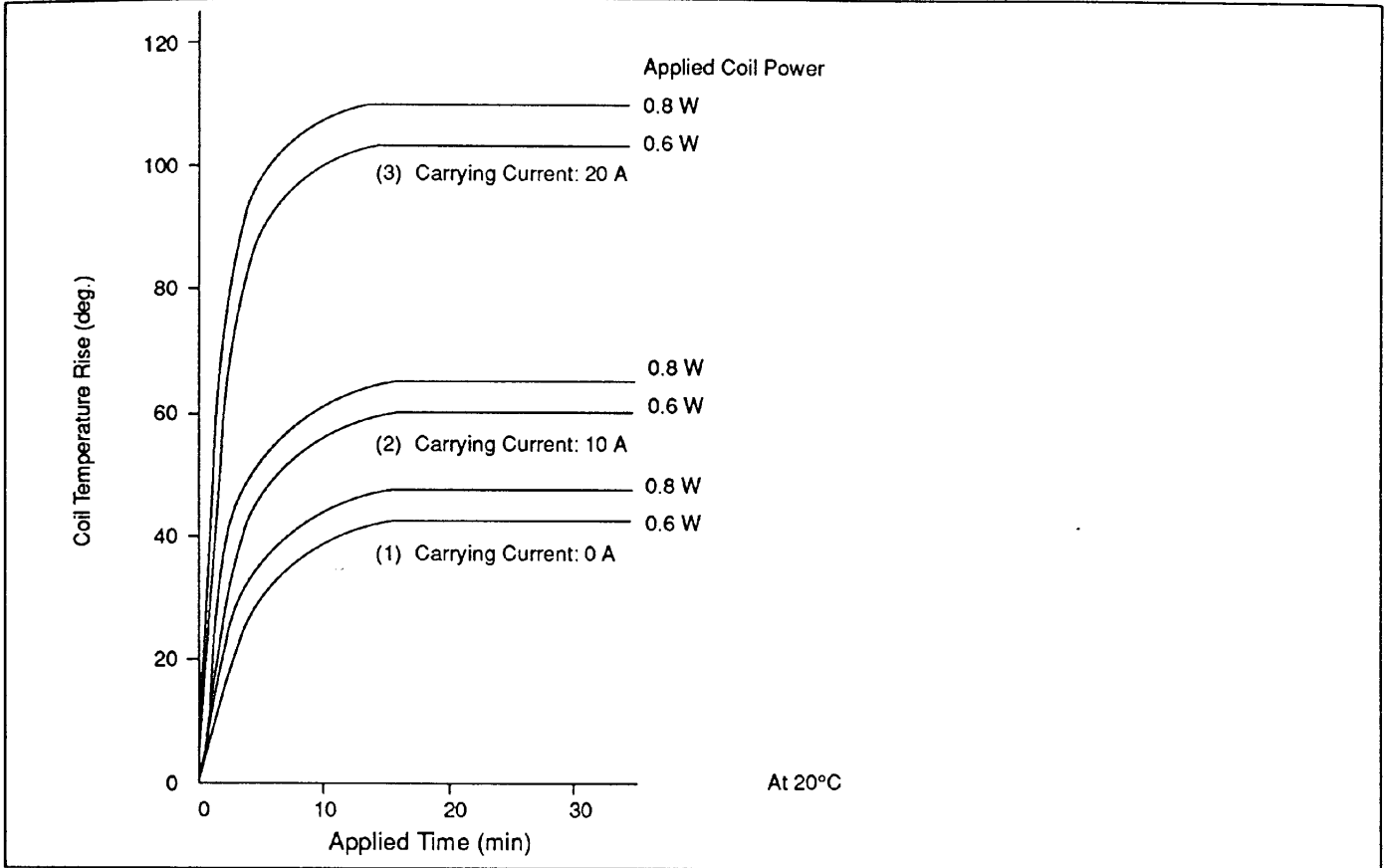

(5) OPERATING COIL VOLTAGE RANGE (EXAMPLE)

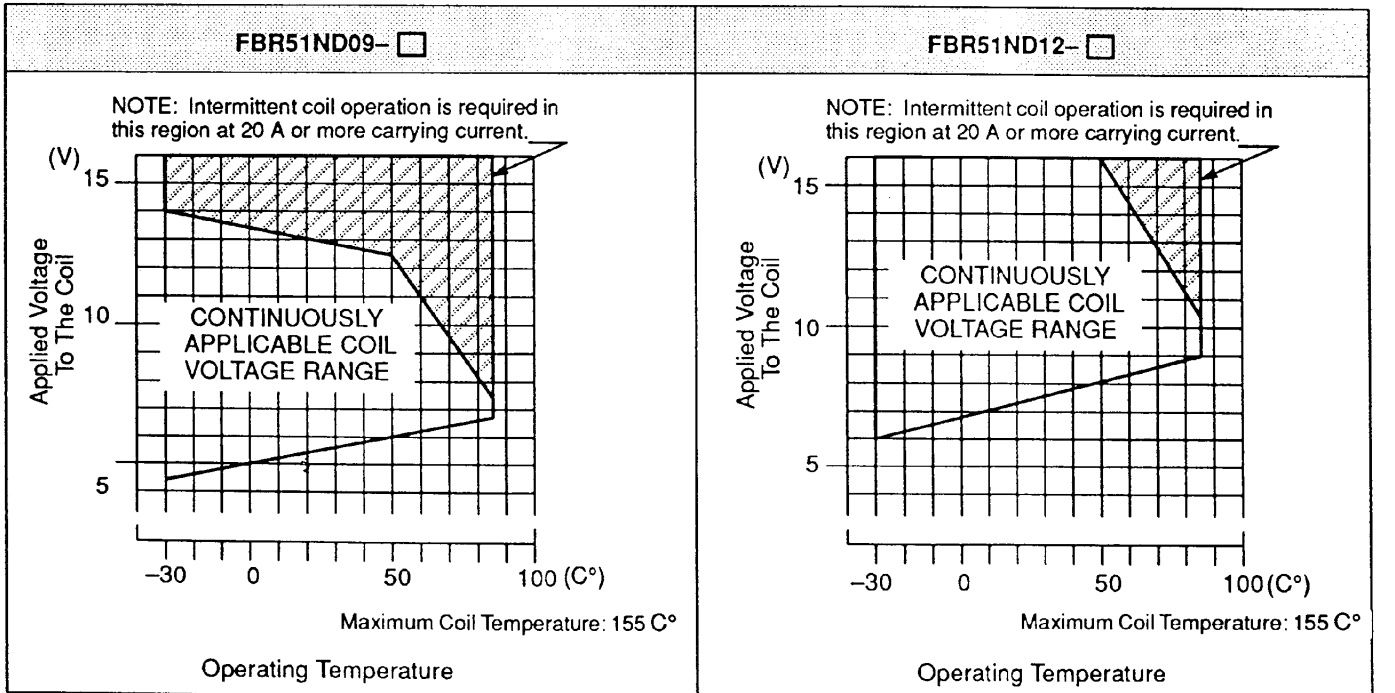

(6) VIBRATION RESISTANCE CHARACTERISTICS

Frequency: 10 to 2000 Hz
 Acceleration: 10 G Max.
 Direction of Vibration: See diagram at right.
 Detection Level: Chatter of 100 μ s min.

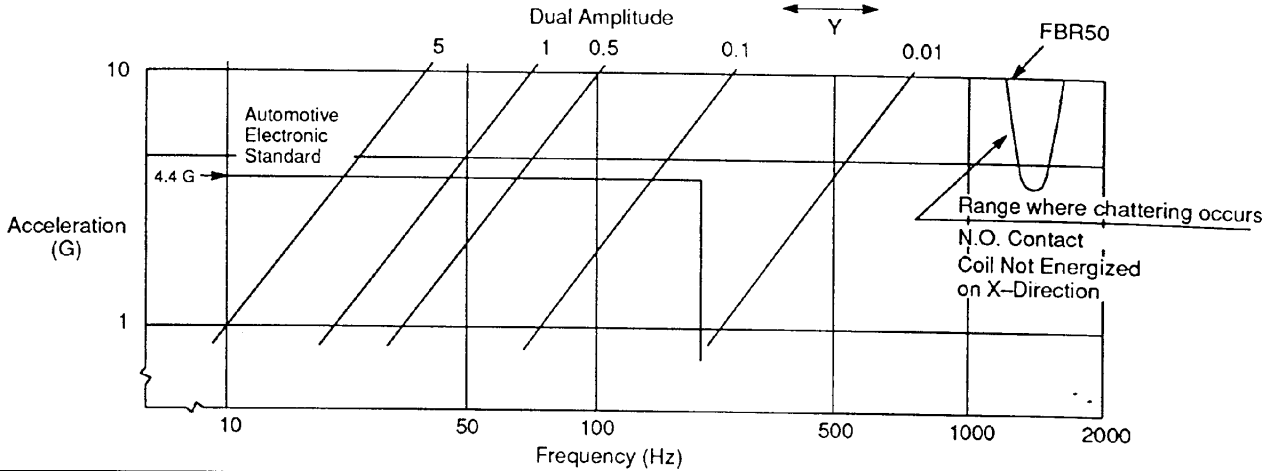

(7) SHOCK RESISTANCE CHARACTERISTICS

Shock Application Time: 11 ms, Half-Sine Wave
 Test Material: Coil, Energized and De-Energized
 Shock Direction: See Diagram at Right
 Detection Level: Chatter of 100 μ s min.

