

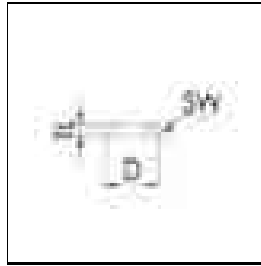

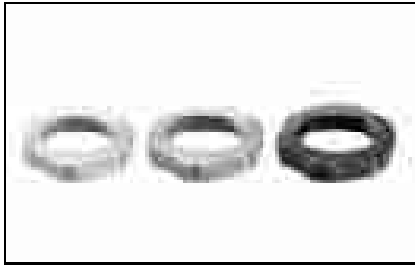

## Locknuts, metric

## Gegenmuttern, metrisch





**Temperature range:** -40°C to 100°C, intermittently to approx. 150°C  
**Material:** Polyamide / reinforced glass fibre

**Einsatztemperatur:** -40°C bis 100°C, kurzzeitig bis ca. 150°C  
**Material:** Polyamid / glasfaserverstärkt

Type	WISKA-No. RAL 7035 □ 100.	WISKA-No. RAL 9005 ■ 100.	WISKA-No. RAL 7001 ■ 100.		 mm	 mm	TL mm
EMUG 12	60770	61780	62712	100/1000	M 12x1,5	18	5
EMUG 16	60771	61781	62713	100/1000	M 16x1,5	22	5
EMUG 20	60772	61782	62714	100/1000	M 20x1,5	27	5
EMUG 25	60773	61783	62715	100	M 25x1,5	32	6
EMUG 32	60774	61784	62716	100	M 32x1,5	40	6
EMUG 40	60775	61785	62717	50	M 40x1,5	50	7
EMUG 50	60776	61786	62718	25	M 50x1,5	60	7
EMUG 63	60777	61787	62719	10	M 63x1,5	75	7

## Locknuts, PG

## Gegenmuttern, PG

Type	WISKA-No. RAL 7035 □ 100.	WISKA-No. RAL 9005 ■ 100.		 mm	 mm	TL mm
MUG 7	60670	60680	100/1000	PG 7	19	5
MUG 9	60671	60681	100/1000	PG 9	22	5
MUG 11	60672	60682	100/1000	PG 11	24	5
MUG 13,5	60673	60683	100/1000	PG 13,5	27	6
MUG 16	60674	60684	100/1000	PG 16	30	6
MUG 21	60675	60685	100/1000	PG 21	36	7
MUG 29	60676	60686	50	PG 29	46	7
MUG 36	60677	60687	25	PG 36	60	8
MUG 42	60678	60688	25	PG 42	73	8
MUG 48	60679	60689	10	PG 48	78	8

<b>EMUG</b>		<b>Datenblatt / data sheet</b>	
Produkt / <i>product</i>	Metrische Sechskantmutter für erhöhte Anforderungen <i>metric hexagonal locknut for higher applications</i>		
Material / <i>material</i>	glasfaserverstärktes Polyamid / <i>polyamide reinforced glas fibre</i>		
Farbe / <i>colour</i>	grau , RAL 7035 oder schwarz , RAL 9005 <i>grey , RAL 7035 or black , RAL 9005</i>		
Chemische Beständigkeit / <i>chemical resistance</i>	beständig gegen: Aceton,Benzin,Benzol,Dieselöl,Fette,Öle, Lösungsmittel für Farben und Lacke <i>resistant to: Acetone,benzine, benzene,diesel oil,oils and greases, paint and varnish solvents</i>		
Spannungsrißgefahr / <i>susceptib. to stress cracking</i>	niedrig <i>low</i>		
Temperaturbeständigkeit / <i>temperature resistance</i>	-40°C bis 100°C , kurzzeitig bis ca.150°C <i>-40°C to 100°C , intermittent up to approx 150°C</i>		

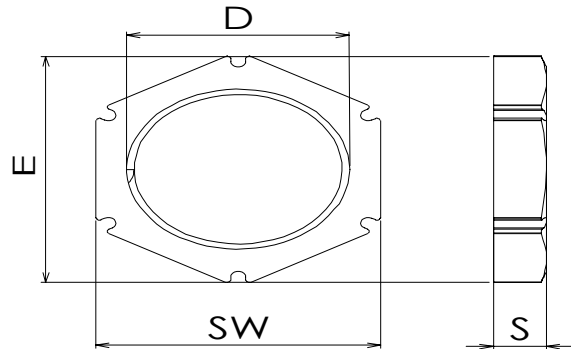

Typ / type	Anschlußgewindegröße / connection thread size D [ mm ]	Schlüsselweite / key width SW [ mm ]	Eckmaß / corner dimension E [ mm ]	S Höhe / height [ mm ]	maximales Drehmoment / maximum torques [ Nm ]	Bestellnummer / order number		VPE / packing unit
						RAL 7035	RAL 9005	
EMUG 12	M 12x1,5	18	20	5	2,0	60770	61780	100/1000
EMUG 16	M 16x1,5	22	24	5	3,5	60771	61781	100/1000
EMUG 20	M 20x1,5	27	29	5	4,0	60772	61782	100/1000
EMUG 25	M 25x1,5	32	35,5	6	10,0	60773	61783	100
EMUG 32	M 32x1,5	40	44,5	6	15,0	60774	61784	100
EMUG 40	M 40x1,5	50	55	7	30,0	60775	61785	50
EMUG 50	M 50x1,5	60	67	7	30,0	60776	61786	25
EMUG 63	M 63x1,5	75	83	7	30,0	60777	61787	10

Die Erstellung des Datenblattes erfolgte nach bestem Wissen und Gewissen. Eine Gewähr kann jedoch nicht übernommen werden. Technische Änderungen vorbehalten./

The correctness of data has been made to the best of our knowledge and no responsibility is accepted. Technical improvement reserved.

Freigabe : 21.10.2002-Sie