



THE NETHERLANDS  
(N E D E R L A N D)



COMMUNICATION

Concerning <sup>(1)</sup>:

- approval granted
- ~~approval extended~~
- ~~approval refusal~~
- ~~approval withdrawn~~
- ~~production definitely discontinued~~



of a type of daytime running lamp pursuant to Regulation number 87.

**Approval number: E4-87R-000129**

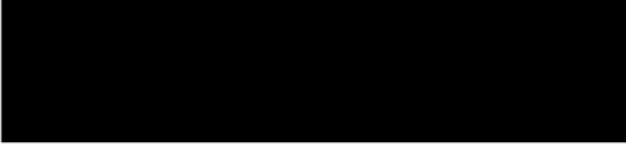
**Extension number: 00**

1. Trade name or mark of the device : 
2. Manufacturer's name for the type of device : TTX
3. Manufacturer's name and address : 
4. If applicable, name and address of the manufacturer's representative : N/A
5. Submitted for approval on : 29 November 2011
6. Technical service responsible for conducting approval tests : RDW  
P.O. Box 777  
2700 AT Zoetermeer  
The Netherlands
7. Date of test report issued by that service : 30 November 2011
8. Number of test report issued by that service : RDW-97/24-3606



9. Concise description:
- By category of lamp: RL
- Number and category and kind of light source(s) <sup>(2)</sup>: N/A, lamp consists of 5 LED's
- Voltage and wattage: 12V / 5W
- Application of an electronic light source control gear: N/A
- Being part of the lamp: ~~yes~~/no <sup>(1)</sup>
  - Being not part of the lamp: ~~yes~~/no <sup>(1)</sup>
- Input voltage supplied by an electronic light source control gear: N/A
- Electronic light source control gear manufacturer and identification number (when the light source control gear is part of the lamp but is not included into the lamp body): N/A
10. Position of the approval mark: On the lens
11. Reason(s) for extension (If applicable): N/A
12. Approval: ~~granted/refused/extended/withdrawn~~ <sup>(1)</sup>
13. Place: Zoetermeer
14. Date: 30 November 2011
15. Signature:   

16. The following documents, bearing the approval number shown above, are available on request:
- Information document No.: TTX-00, 3 pages dated November 18, 2011

<sup>(1)</sup> Strike out what does not apply.

<sup>(2)</sup> For daytime running lamps with non-replaceable light sources indicate the number and total wattage of the light sources used.



Guangzhu Fuzhixiang Auto Accessories Co., Ltd  
No.1, Chaoliang Road, Yingxi Village, Taihe Town, Baiyun District,  
Guangzhou, China

Nov.18, 2011

Dear Sirs,

We would like to apply for the type approval according to ECE .

Function	ECE approval number
Daytime running lamp	E4-87R-000129

Trade name or mark	:	 JIN ZHONG
Manufacturer's name for type of device	:	TTX
Variants	:	TTX-8006,8007,8008,8009,8010,8011,8012,8013
Name and address of manufacturer	:	

We confirm that the above mentioned application has not been submitted to any other EC member state nor has any other member state granted a corresponding approval.

Sincerely:



First application date	Nov.18, 2011
------------------------	--------------

## 1、 Specification data

Type		TTX
Variants		TTX-8006,8007,8008,8009,8010,8011,8012,8013
Function		Daytime running lamp
Color		White
Rated	Voltage	12V
	Wattage	5W
Application Regulation ECE		R87.00
Location of marking	Filament lamp category	5*LED
		Marked on housing
	Trade mark	 JIN ZHONG
		Marked on lens
Approval mark	Marked on lens	

## 2、 Construction and material

Construction	Material	Remarks
Lens	PC	--
Housing	AL	painting on the inside surface
Electrical Wiring	Copper covered with insulation	--

3、 Name and address of manufacturer :



4、 Applicant's name and address : N/A



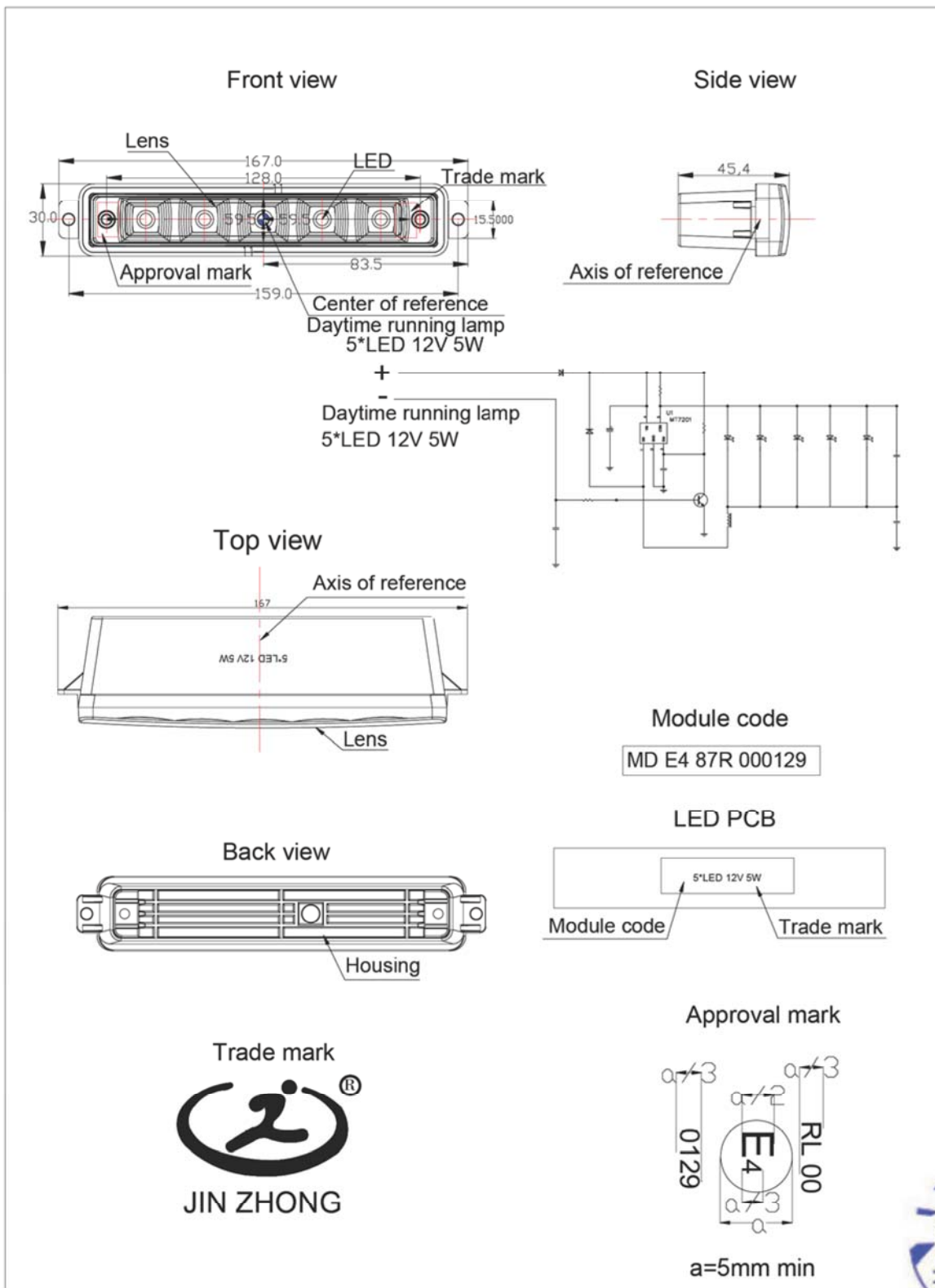

Product Type	TTX
General assembly drawing	
Drawing No.	TTX-01