

Reflektor LED Serie 1-Weg-Gleichrichtung

Spezifikation

Ultrahelle 3 mm LED, hochreflektierender Kunststoffkörper (Reflektor) mit Farbring in Leuchtfarbe. Integrierter Vorwiderstand und Schutzdiode. Dadurch ist auch AC-Betrieb möglich, wobei die Helligkeit und die Stromaufnahme bei ca. 50% der Werte für DC-Betrieb liegen. Mittelkontakt serienmäßig als Anoden-Anschluss (+).
RoHS gemäß 2002/95/EC

Material

Reflektor: PBT, weiß
Distanzstück: PC in Leuchtfarbe

Einbau-Öffnung

min. Ø5,8 mm, min. Ø7,2 mm

Anschluss (Socket)

E5,5 / BA5s / BA7s / MG / T5,5k / T5,5 / T6,8 / W2x4,6

Optionen

Sonderspannungen bis 60V

Schaltbild

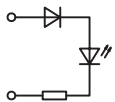

Reflector LED Series One-Way-Rectification

Specification

With ultrabright 3 mm LED, high reflecting plastic body (reflector) with ring in light colour. Integrated resistor and protection diode. Therefore it is also possible AC-operation. The values of luminous intensity and current consumption at DC-operation are approx. 50%. In standard execution, the centre contact is the anode (+) connection.
RoHS compliant 2002/95/EC

Material

Reflector: PBT, white
Distance bush: PC in light colour

Mounting-hole

min. Ø5.8 mm, min. Ø7.2 mm

Connection (Socket)

E5.5 / BA5s / BA7s / MG / T5.5k / T5.5 / T6.8 / W2x4.6

Options

Other voltages up to 60V on request

Circuit diagram

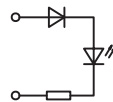

LED optische-, elektrische Kenn- / Grenzdaten LED optical-, electrical-Characteristics max. ratings	Zeichen / sign Einheit / unit Parameter	Farbe / colour rot / red	Farbe / colour gelb / yellow	Farbe / colour grün / green	Farbe / colour blau / blue	Farbe / colour weiß / white	Farbe / colour ultra-grün / ultra green
LED Typ / LED type		U3	U3	H3	U3	U3	U3
Lichtstärke typ. / typical luminous intensity	I_v / mcd / $I_f = 20$ mA	1300	700	200	2800	3700	9200
Dominante Wellenlänge / dominant wavelength	λ_{DOM} / nm	628	588	568	470	x = 0,33-0,36 y = 0,32-0,35	525
Abstrahlwinkel / viewing angle	2ϕ / °	50	50	50	30	60	30
Betriebstemperatur / operating temperature	T_{OP} / °C	-40 / +70	-40 / +70	-40 / +70	-40 / +70	-40 / +70	-40 / +70
Lagertemperatur / storage temperature	T_{STG} / °C	-40 / +100	-40 / +100	-40 / +100	-40 / +100	-40 / +100	-40 / +100
Stromaufnahme / Current consumption	I_{CC} / mA / typ. 12V I_{CC} / mA / typ. 24V	16,6 11,8 / 14,2 MEDT68	16,6 11,8 / 14,2 MEDT68	16,6 11,8 / 14,2 MEDT68	14,5 11,1 / 13,4 MEDT68	14,5 11,1 / 13,4 MEDT68	14,5 11,1 / 13,4 MEDT68
Lebensdauer* typ. bei 25°C / Life time* typ. at 25°C	h	50.000	50.000	50.000	50.000	20.000	50.000

* Abfall der Helligkeit auf 50% des Ausgangswerts

* reduction of the brightness about 50% of the initial value

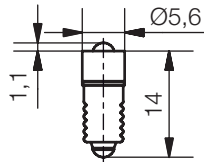

Sockel E5,5 / socket E5.5 Typ / type	Artikel Nr.: / part number	
	15/18 V	24/28 V
rot / red	MEDE 5502	MEDE 5504
gelb / yellow	MEDE 5512	MEDE 5514
grün / green	MEDE 5522	MEDE 5524
blau / blue	MEDE 5542	MEDE 5544
weiß / white	MEDE 5562	MEDE 5564
ultra-grün / ultra-green	MEDE 5572	MEDE 5574

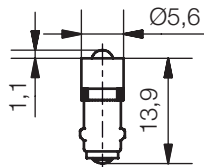

Sockel BA5s/ socket BA5s Typ / type	Artikel Nr.: / part number	
	12/14 V	24/28 V
rot / red	MEDB 0502	MEDB 0504
gelb / yellow	MEDB 0512	MEDB 0514
grün / green	MEDB 0522	MEDB 0524
blau / blue	MEDB 0542	MEDB 0544
weiß / white	MEDB 0562	MEDB 0564
ultra-grün / ultra-green	MEDB 0572	MEDB 0574

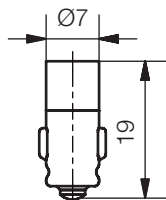

Sockel BA7s / socket BA7s Typ / type	Artikel Nr.: / part number	
	12/14 V	24/28 V
rot / red	MEDB 0702	MEDB 0704
gelb / yellow	MEDB 0712	MEDB 0714
grün / green	MEDB 0722	MEDB 0724
blau / blue	MEDB 0742	MEDB 0744
weiß / white	MEDB 0762	MEDB 0764
ultra-grün / ultra-green	MEDB 0772	MEDB 0774

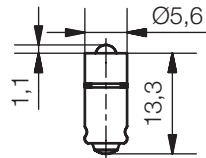

Sockel MG / socket MG
Typ / type

Artikel Nr.: / part number

12/14 V

24/28 V

rot / red	MEDG 5702	MEDG 5704
gelb / yellow	MEDG 5712	MEDG 5714
grün / green	MEDG 5722	MEDG 5724
blau / blue	MEDG 5742	MEDG 5744
weiß / white	MEDG 5762	MEDG 5764
ultra-grün / ultra-green	MEDG 5772	MEDG 5774

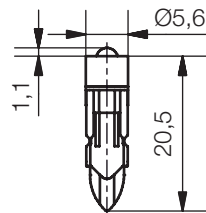

Sockel T5,5k / socket T5.5k
Typ / type

Artikel Nr.: / part number

12/14 V

24/28 V

rot / red	MEDK 5502	MEDK 5504
gelb / yellow	MEDK 5512	MEDK 5514
grün / green	MEDK 5522	MEDK 5524
blau / blue	MEDK 5542	MEDK 5544
weiß / white	MEDK 5562	MEDK 5564
ultra-grün / ultra-green	MEDK 5572	MEDK 5574

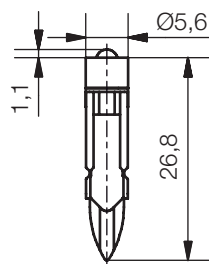

Sockel T5,5 / socket T5.5
Typ / type

Artikel Nr.: / part number

12/14 V

24/28 V

rot / red	MEDT 5502	MEDT 5504
gelb / yellow	MEDT 5512	MEDT 5514
grün / green	MEDT 5522	MEDT 5524
blau / blue	MEDT 5542	MEDT 5544
weiß / white	MEDT 5562	MEDT 5564
ultra-grün / ultra-green	MEDT 5572	MEDT 5574

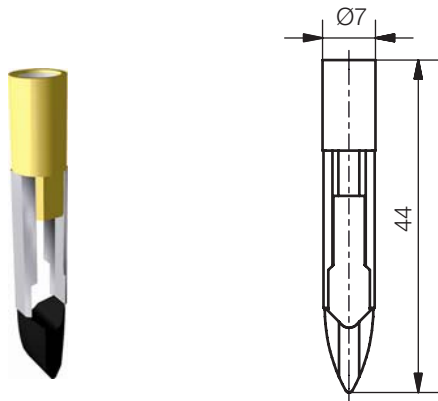

Sockel T6,8 / socket T6.8 Typ / type	Artikel Nr.: / part number	
	12/14 V	24/32 V
rot / red	MEDT 6802	MEDT 6804
gelb / yellow	MEDT 6812	MEDT 6814
grün / green	MEDT 6822	MEDT 6824
blau / blue	MEDT 6842	MEDT 6844
weiß / white	MEDT 6862	MEDT 6864
ultra-grün / ultra-green	MEDT 6872	MEDT 6874

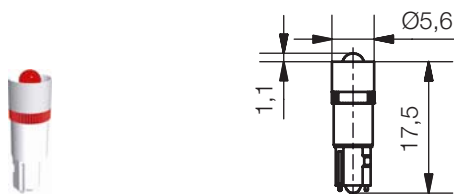

Sockel W2x4,6 / socket W2x4.6 Typ / type	Artikel Nr.: / part number	
	12/14 V	24/28 V
rot / red	MEDW 4602	MEDW 4604
gelb / yellow	MEDW 4612	MEDW 4614
grün / green	MEDW 4622	MEDW 4624
blau / blue	MEDW 4642	MEDW 4644
weiß / white	MEDW 4662	MEDW 4664
ultra-grün / ultra-green	MEDW 4672	MEDW 4674